

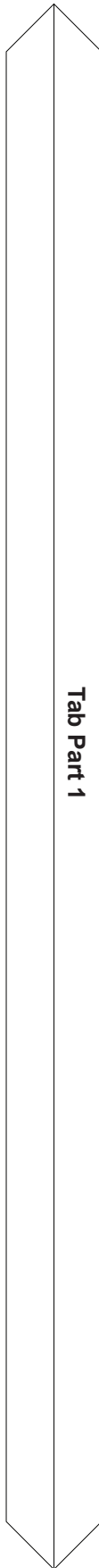

1



Tab Part 1

6

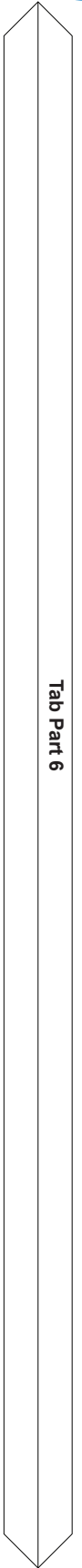
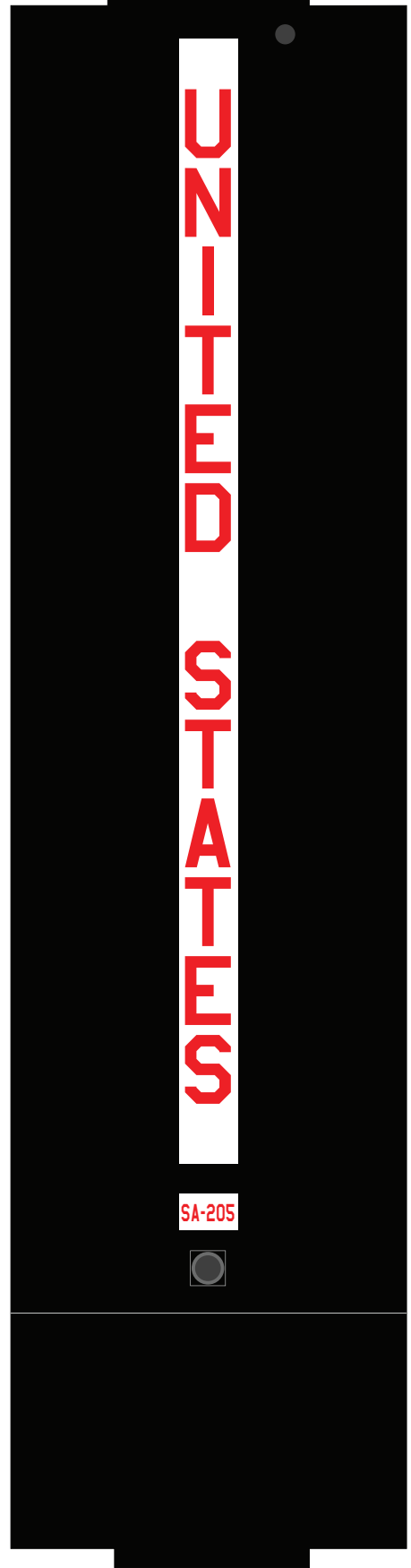

Tab Part 6

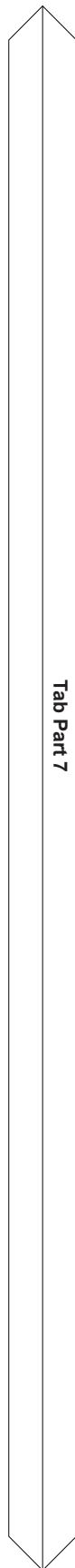
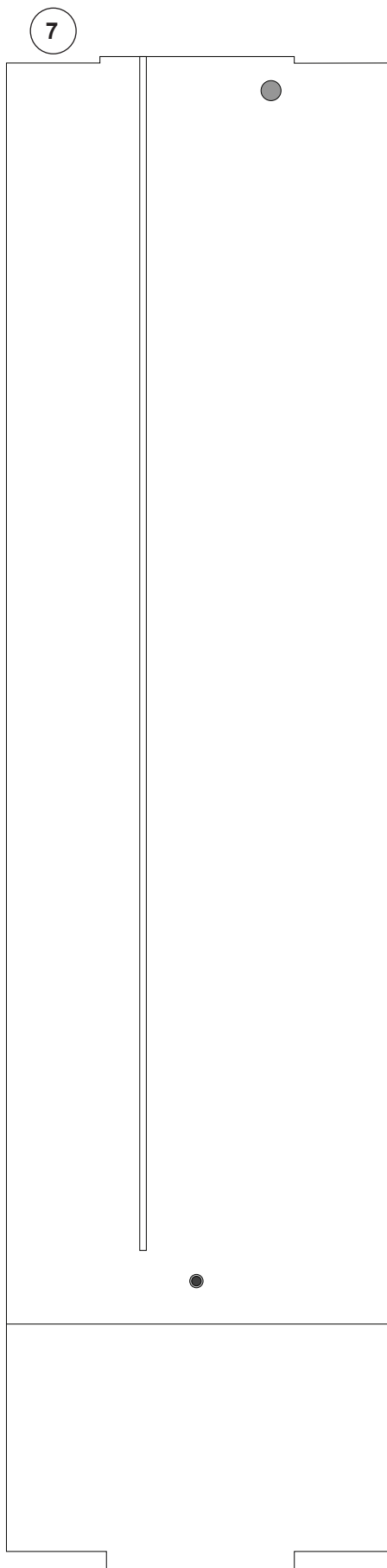

Tab Part 7

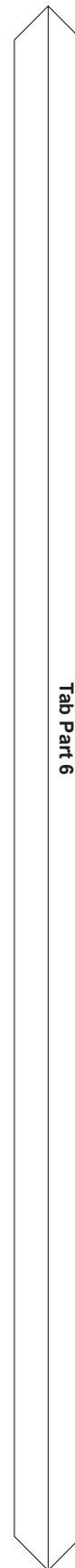
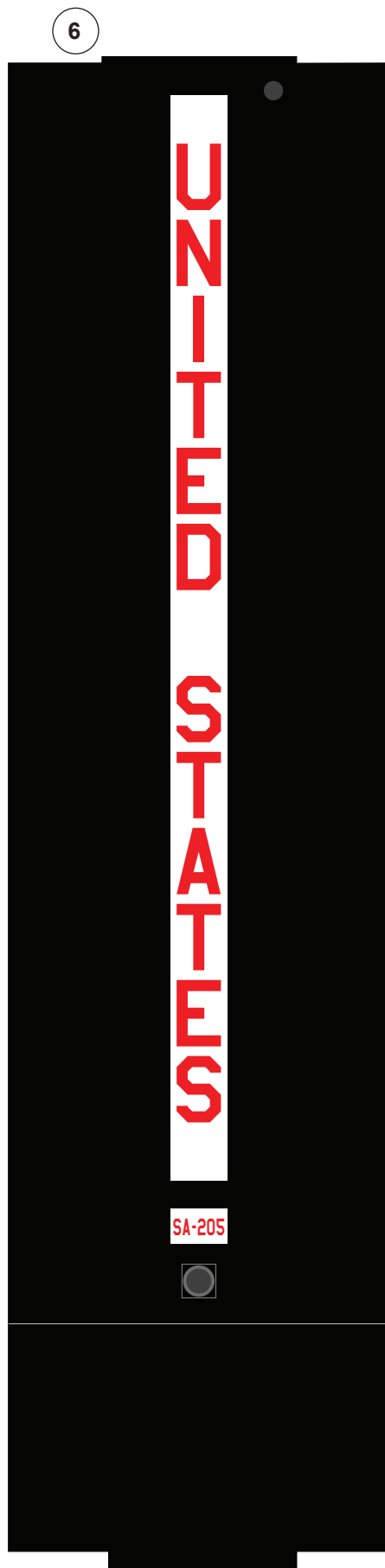

Tab Part 6

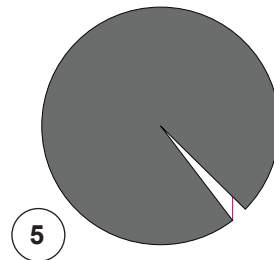

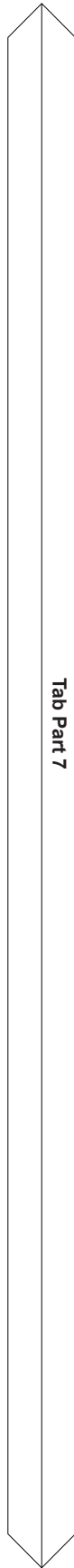
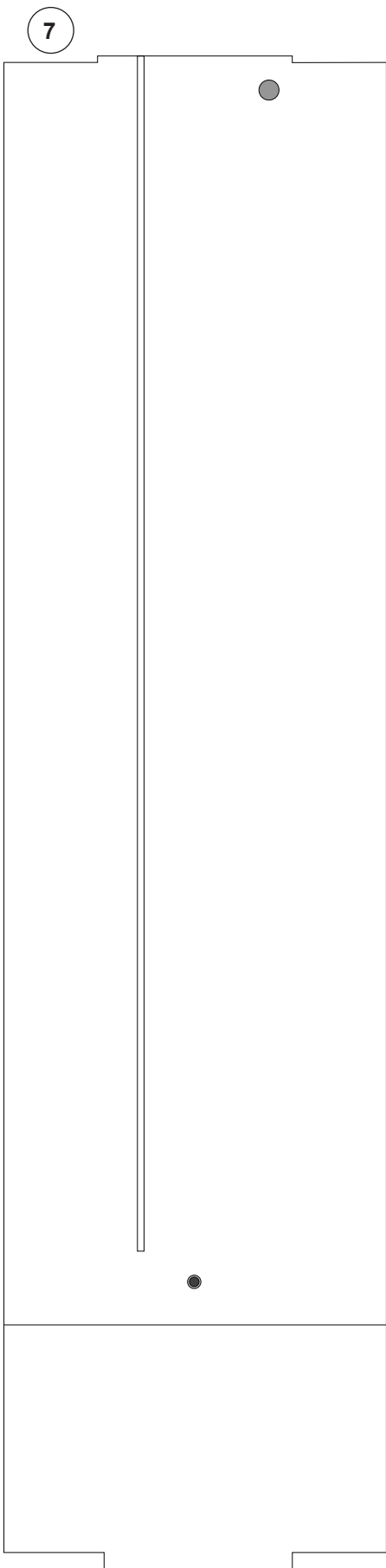

Tab Part 7

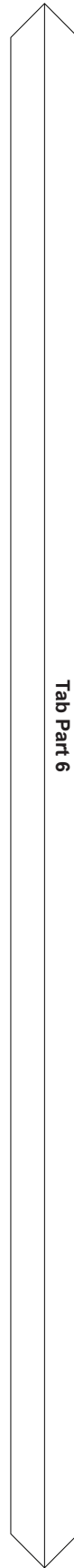
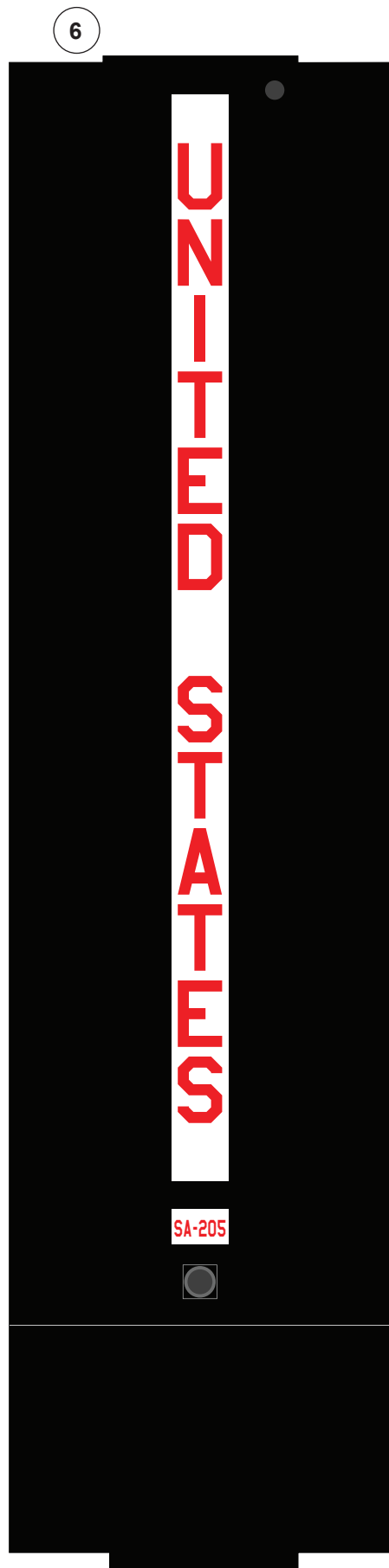

Tab Part 6

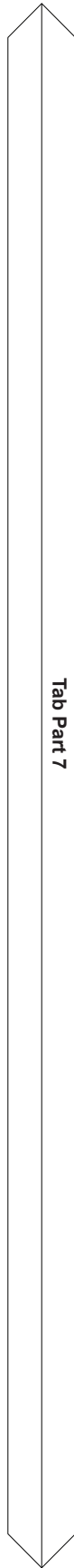
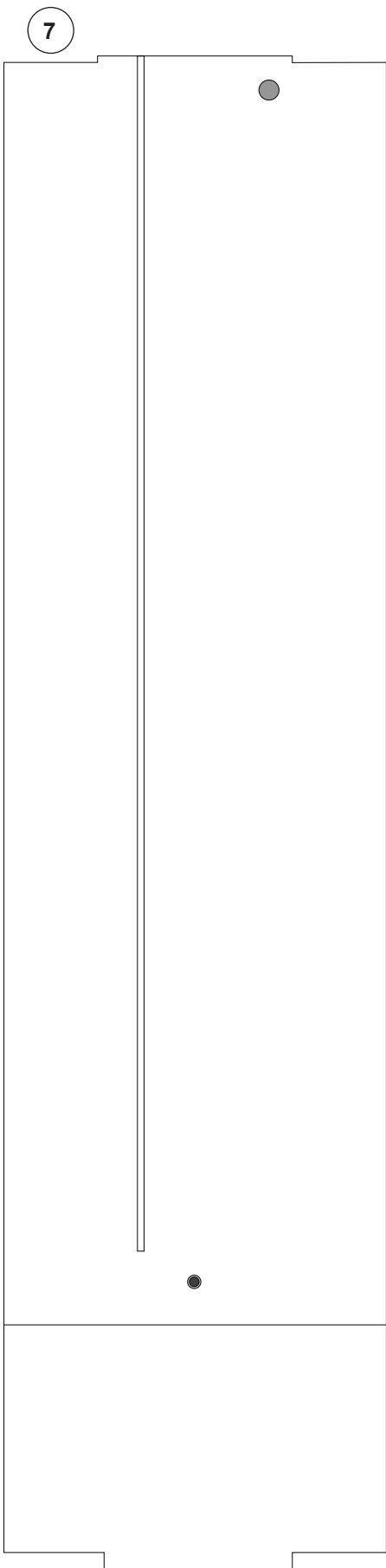

Tab Part 7

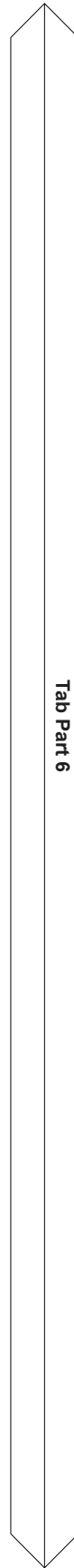
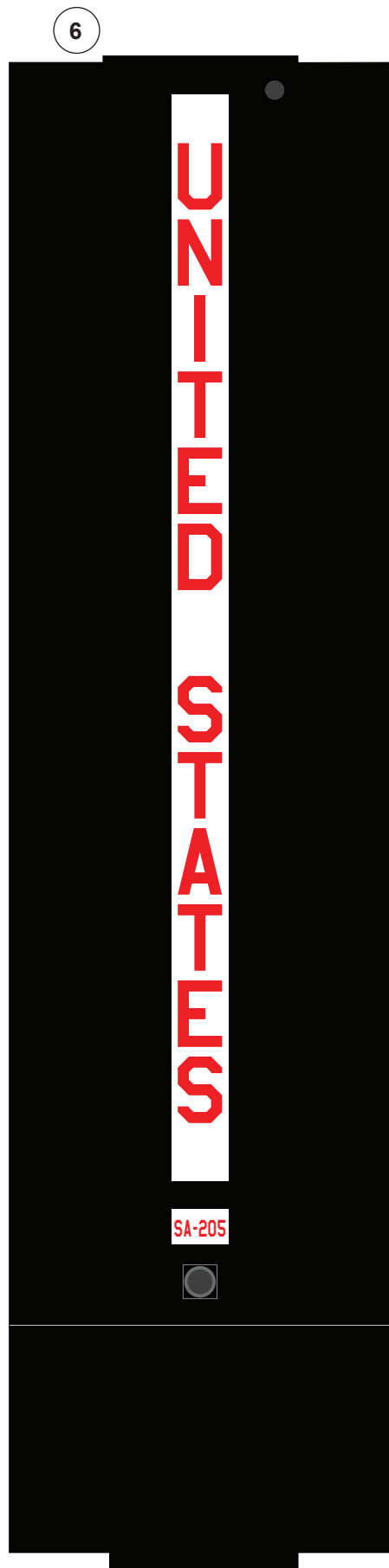

Tab Part 6

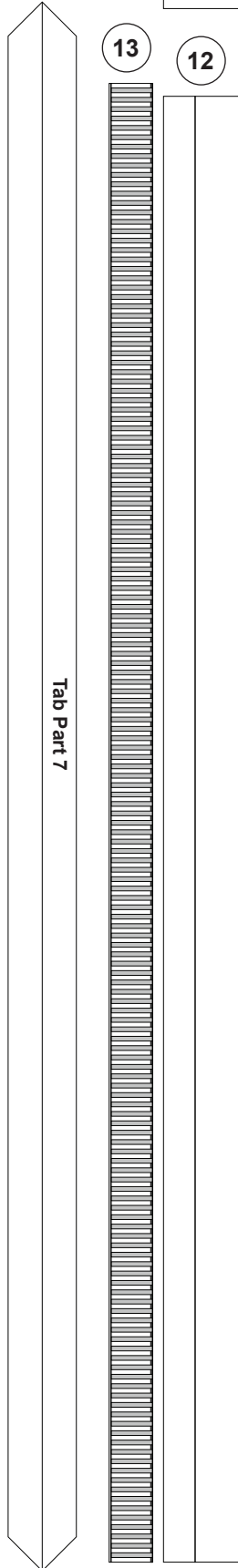
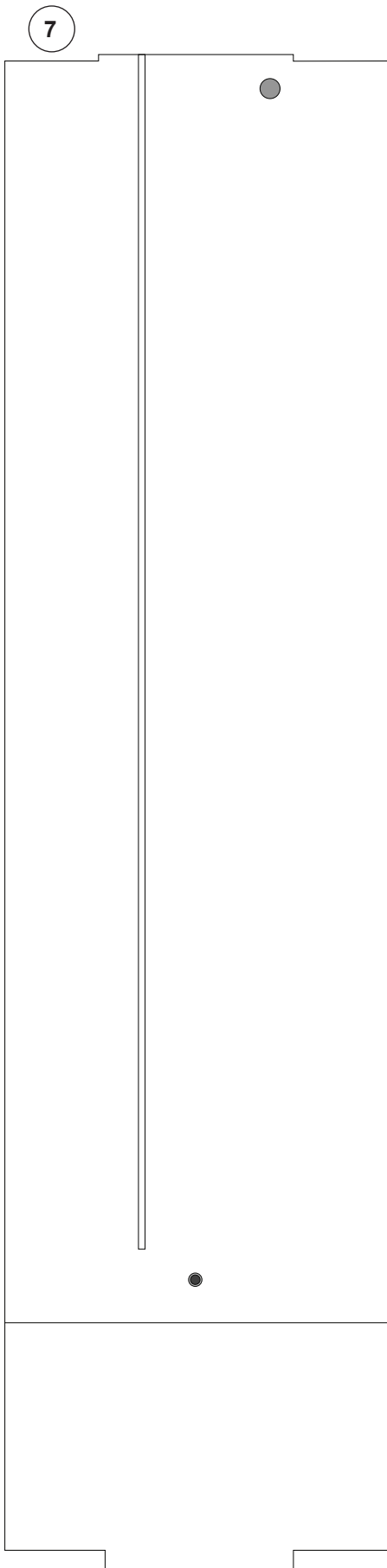

Tab  
Part 12

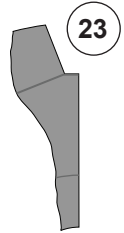
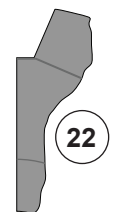
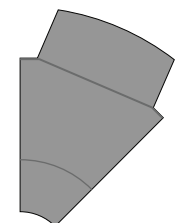
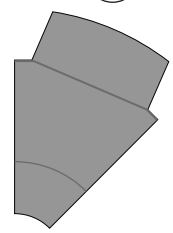
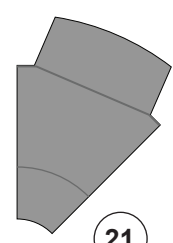
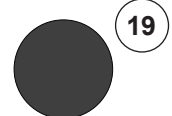
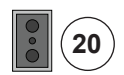
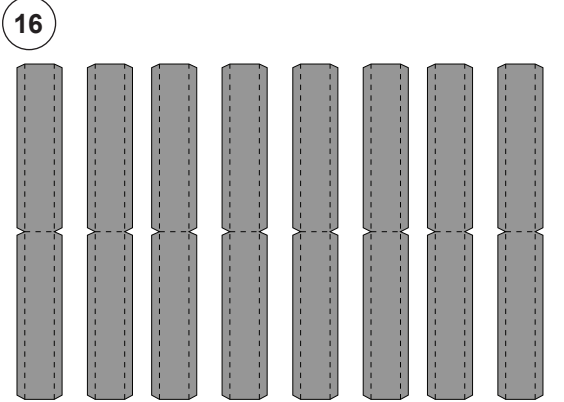
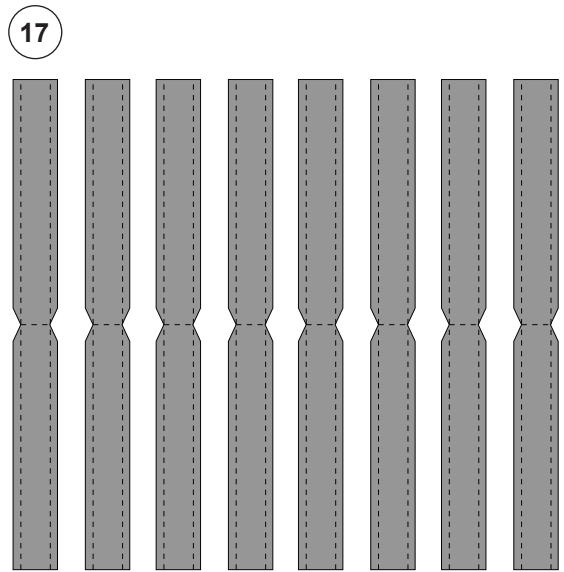



Tab Part 2

2

3

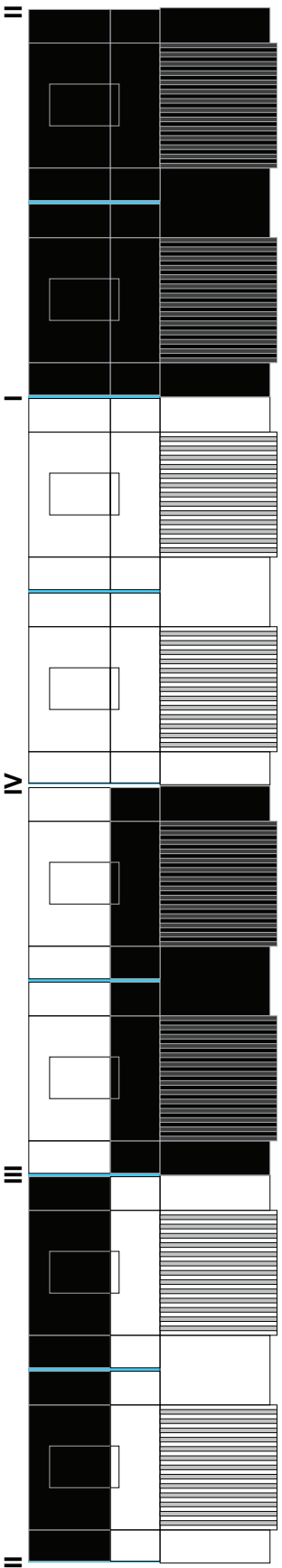

Inboard Engines

Outboard Engines

8

9

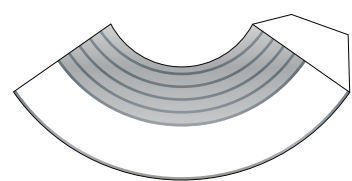
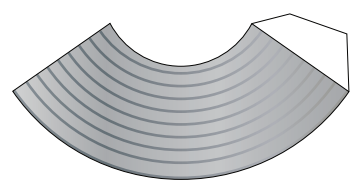
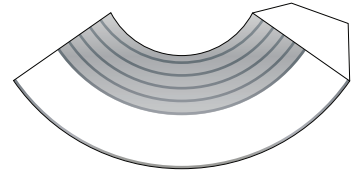
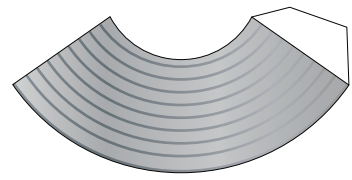
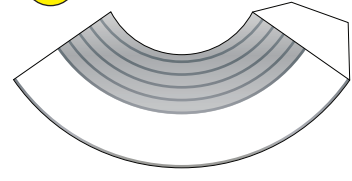
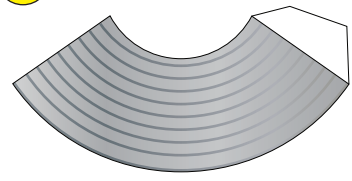
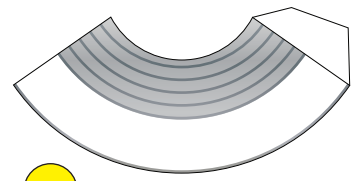
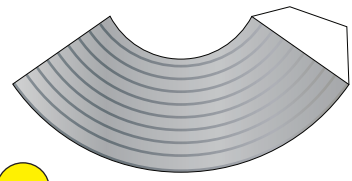

4

10

Engine Liner

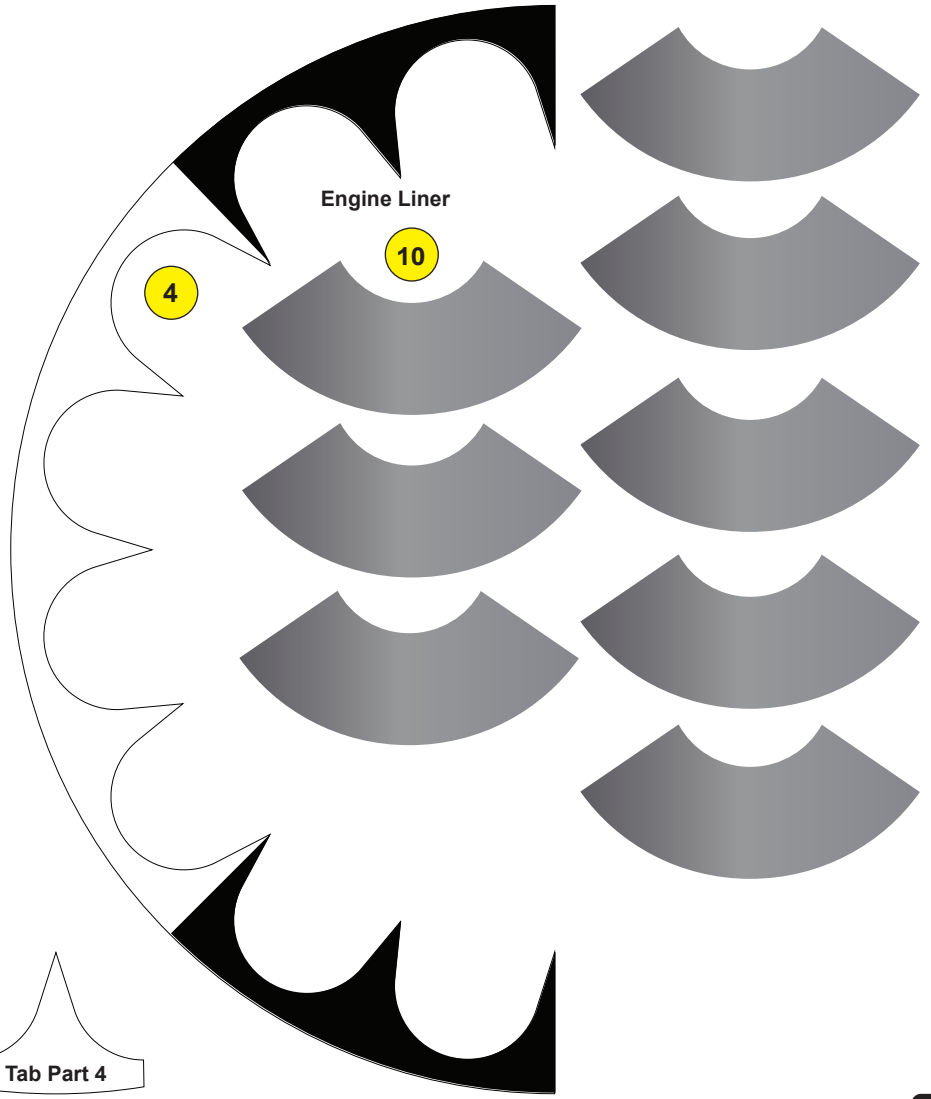

Tab Part 4

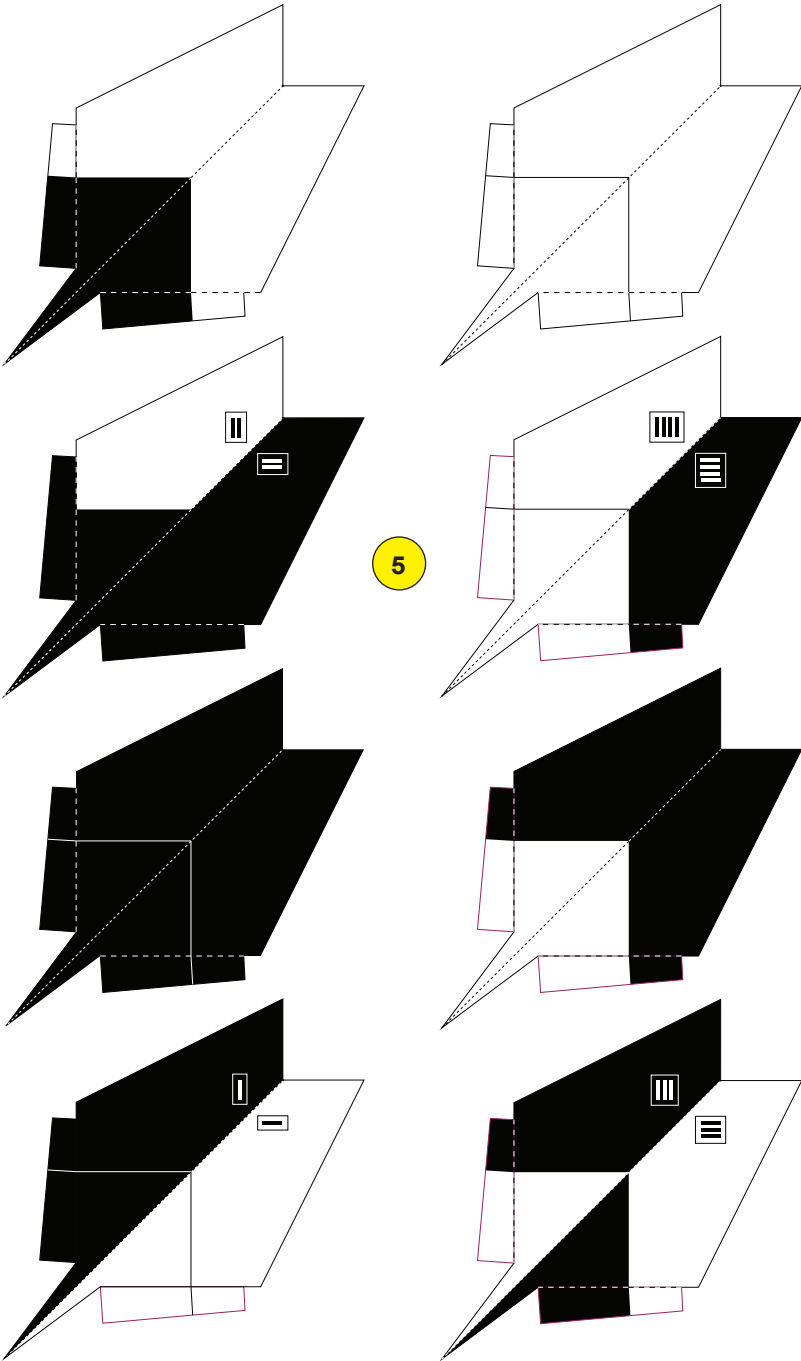

5

Bottom inner ring joins here

2

3

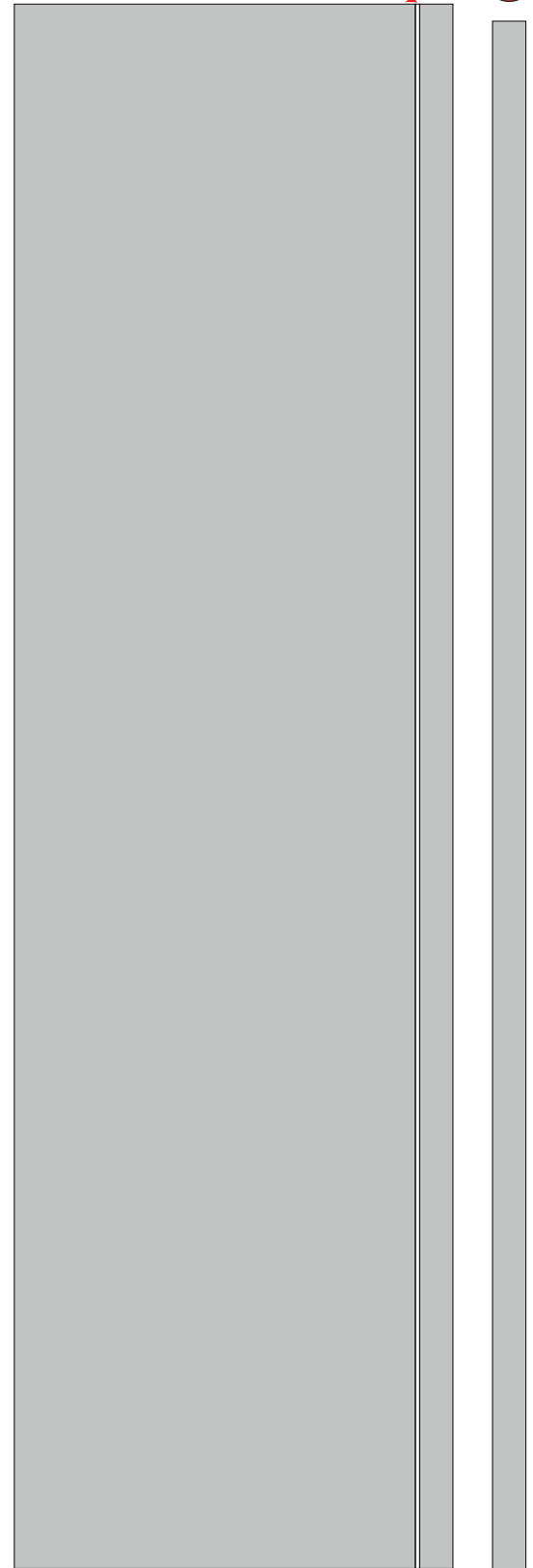

7

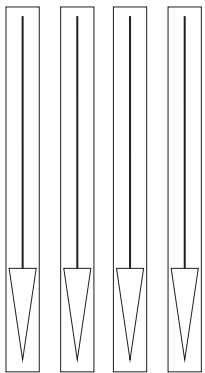

8

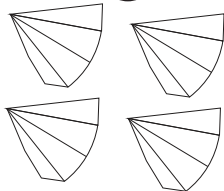

6

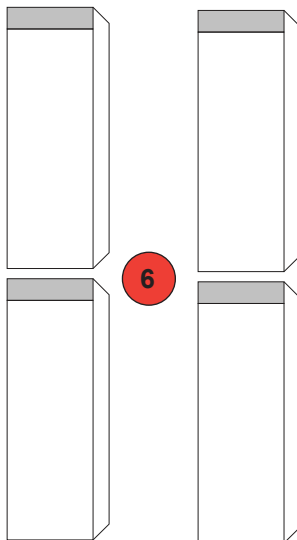



1

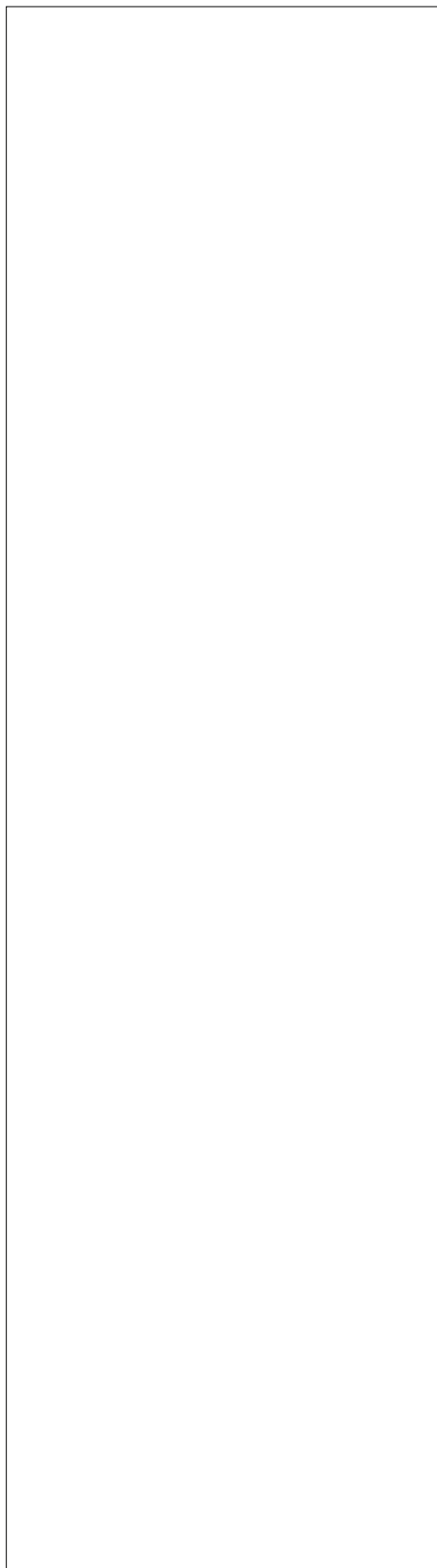

5

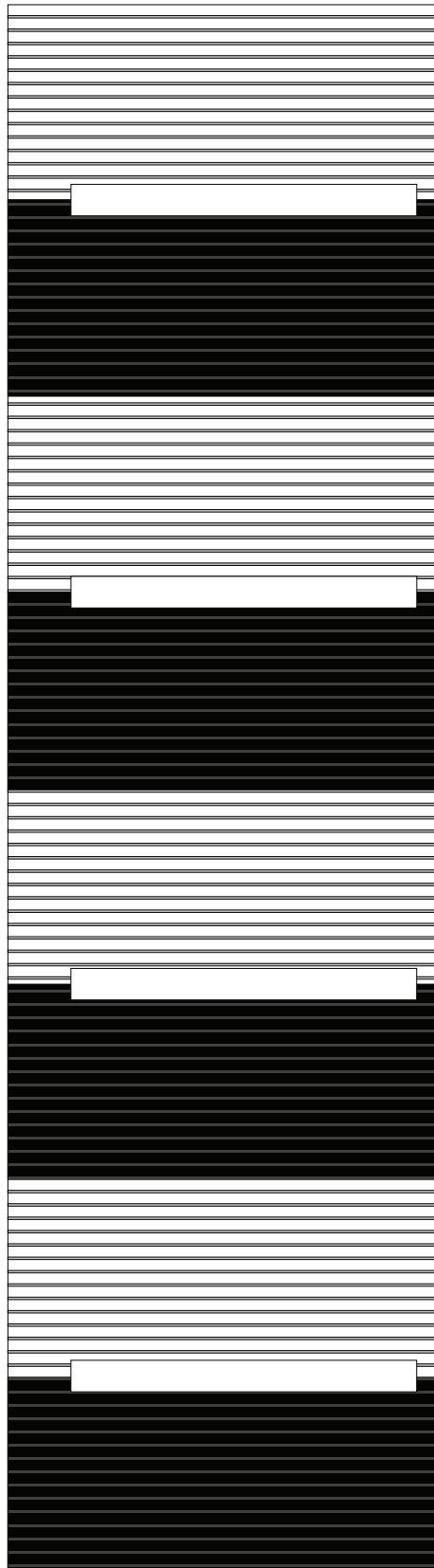

3

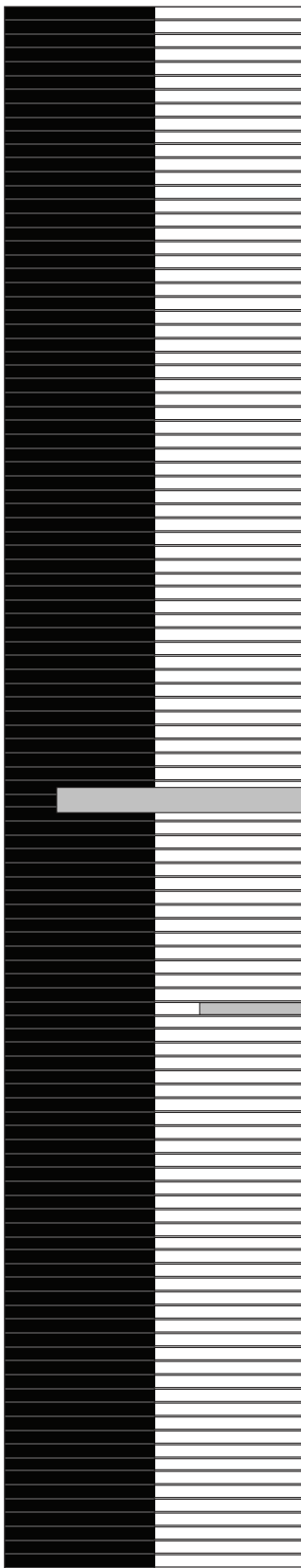

2







Part 1 Side Tab

1

5

U S A

U S A

3

7

2

U S A

8

U S A

6

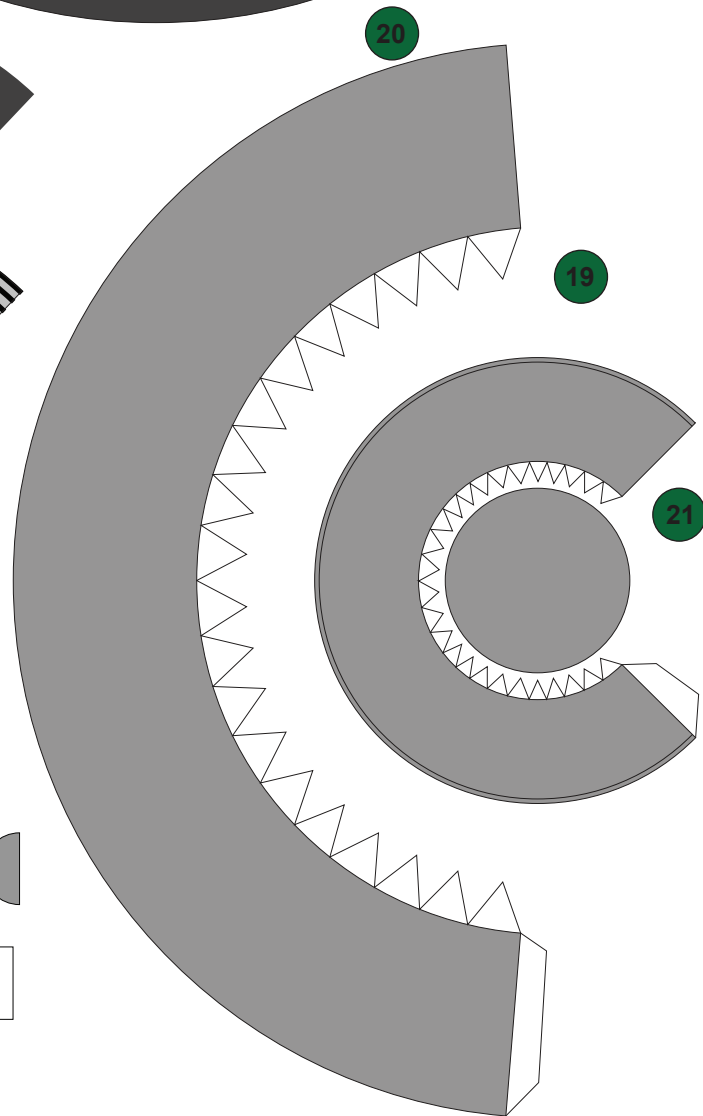
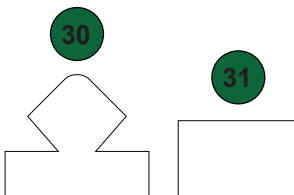
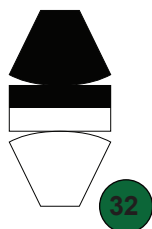
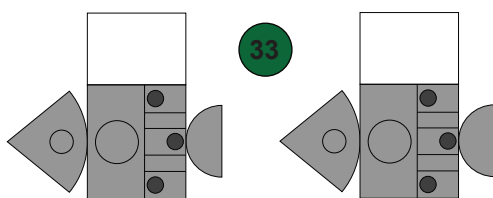
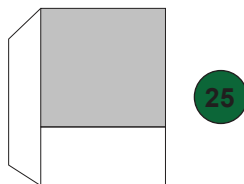
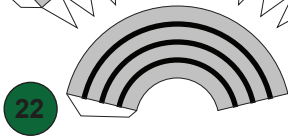
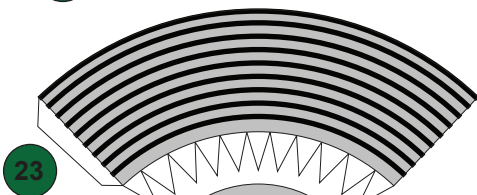
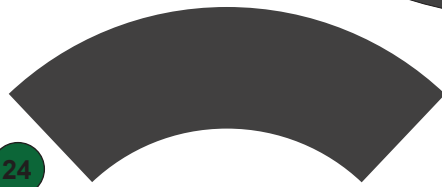
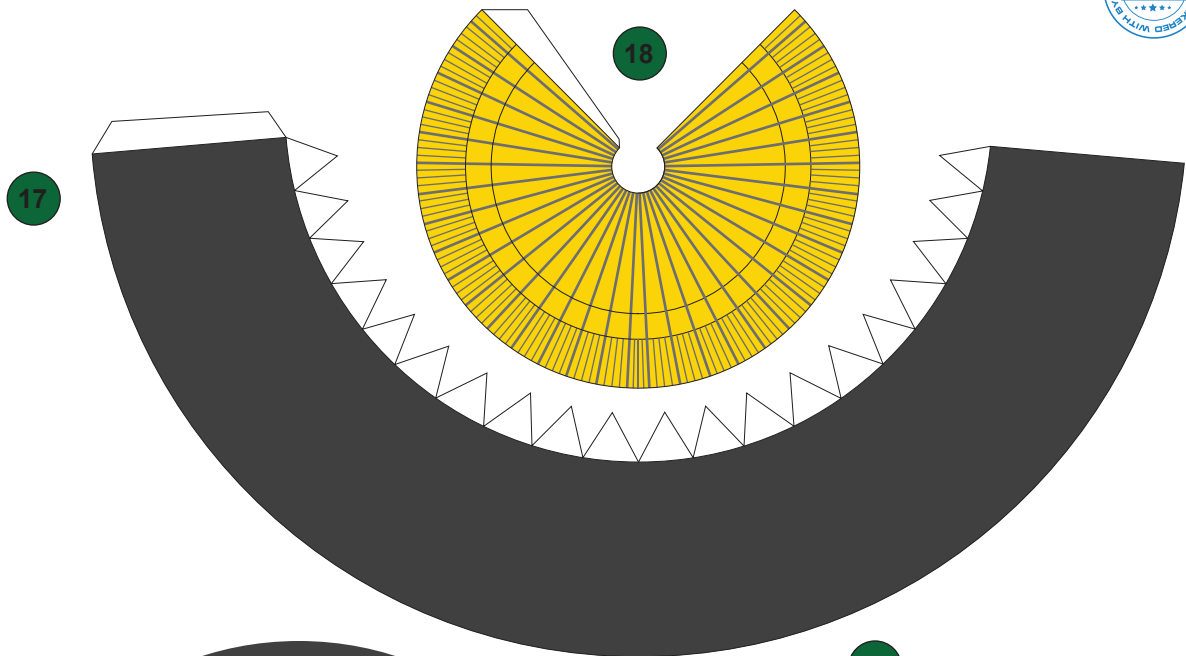

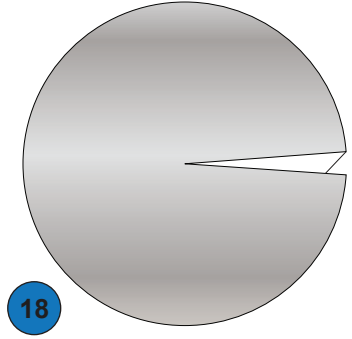
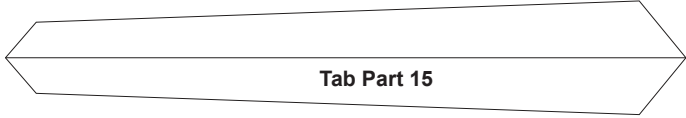
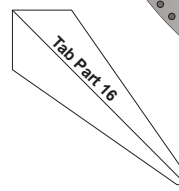
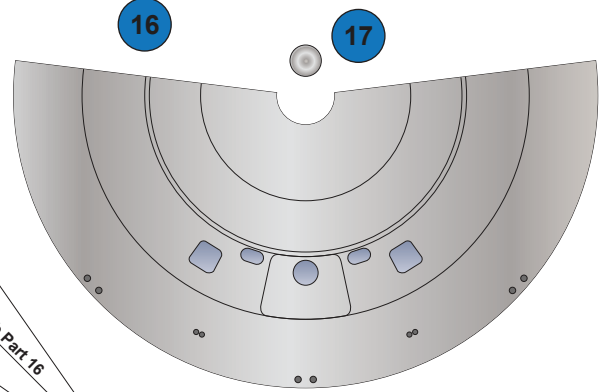
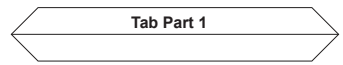
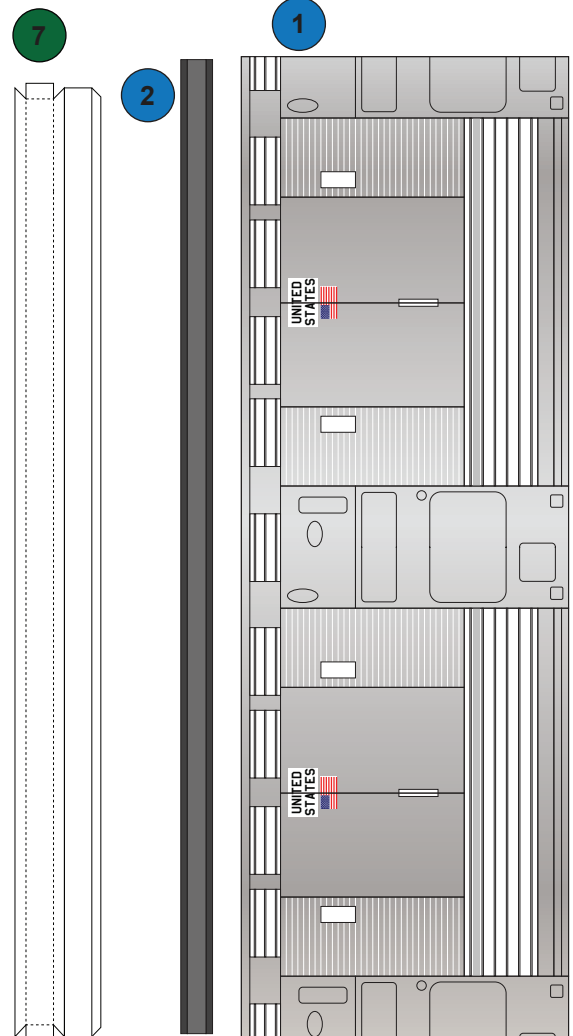
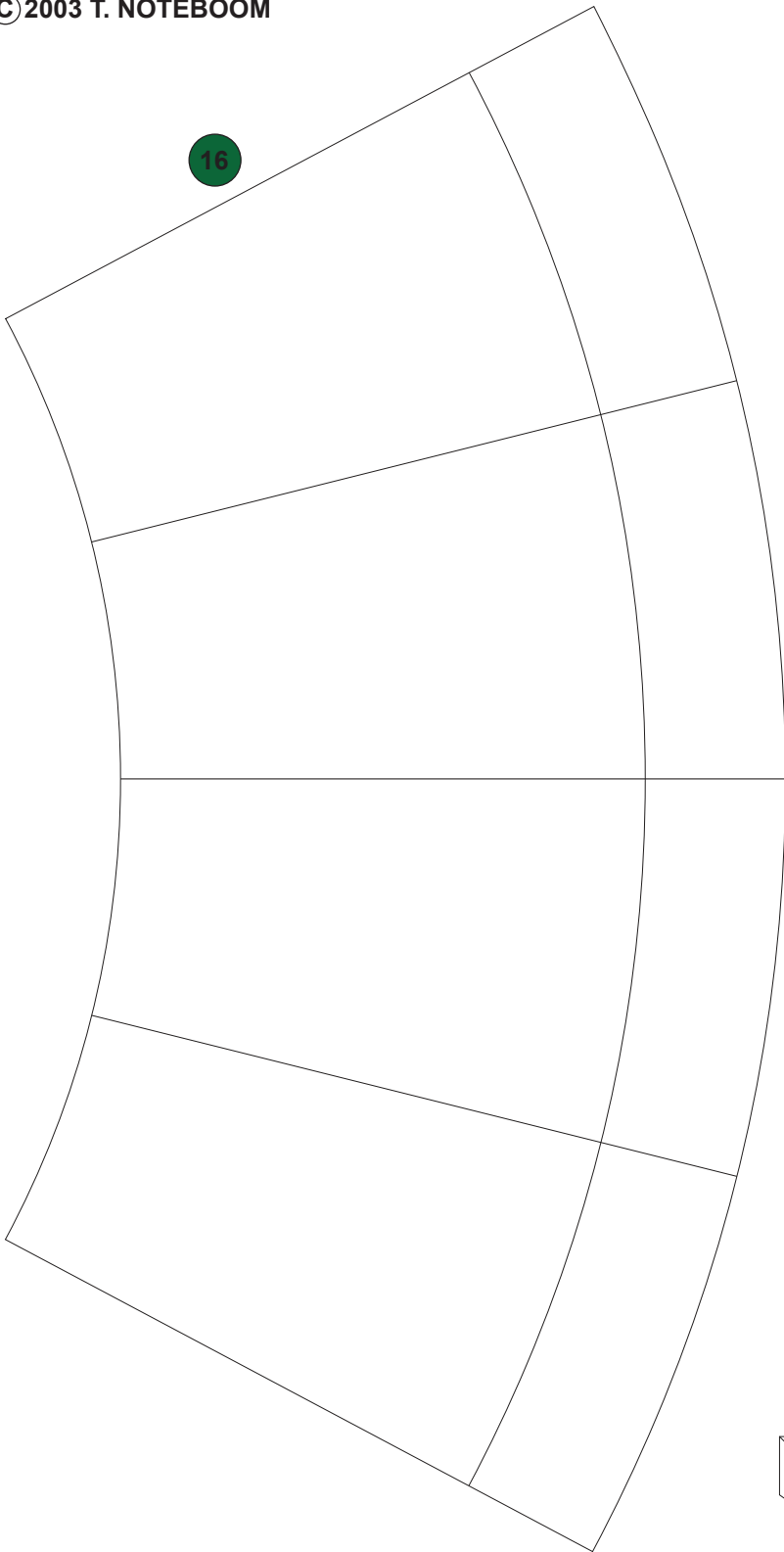

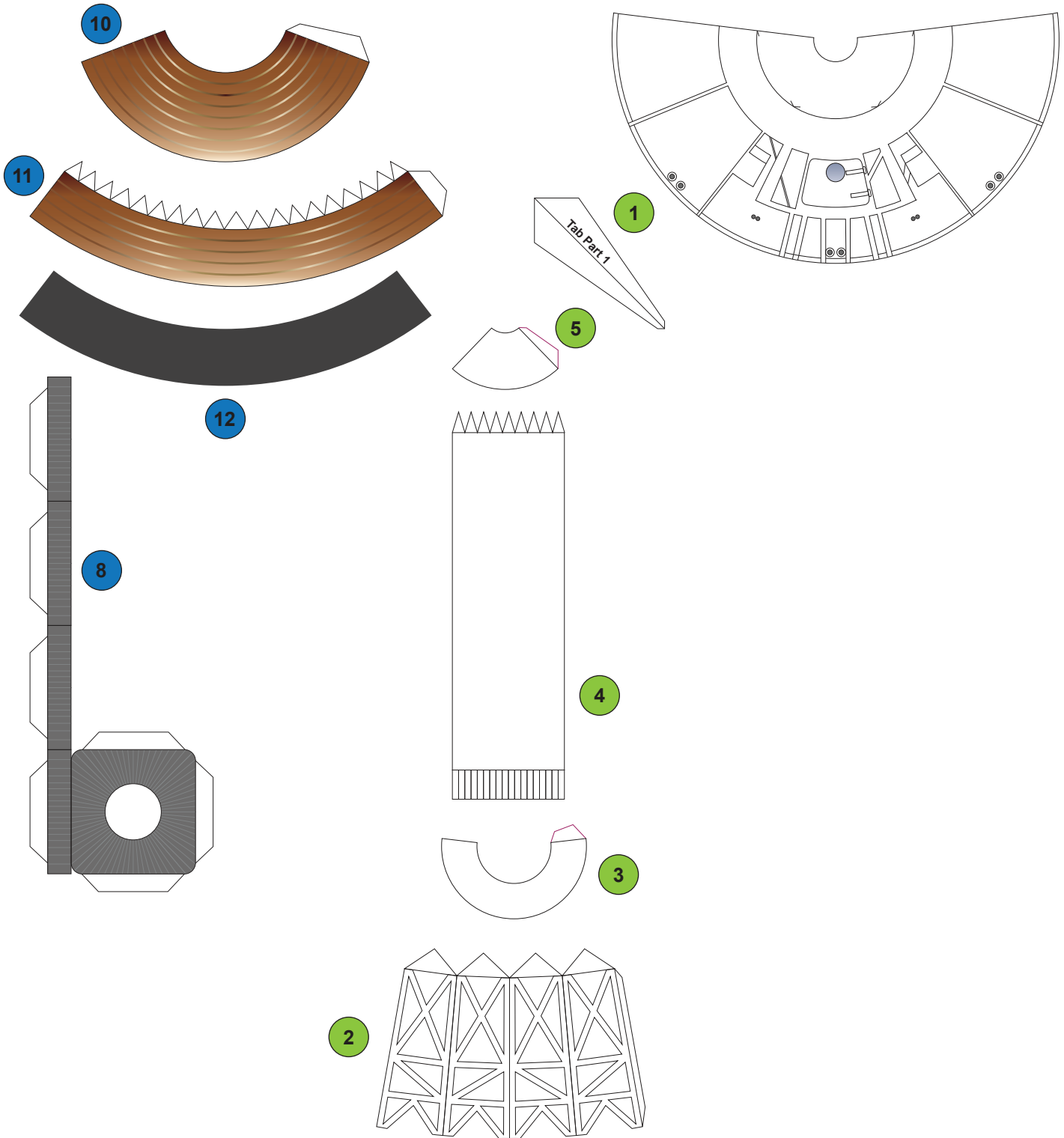

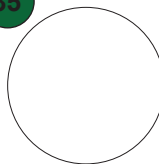
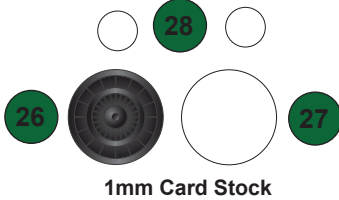
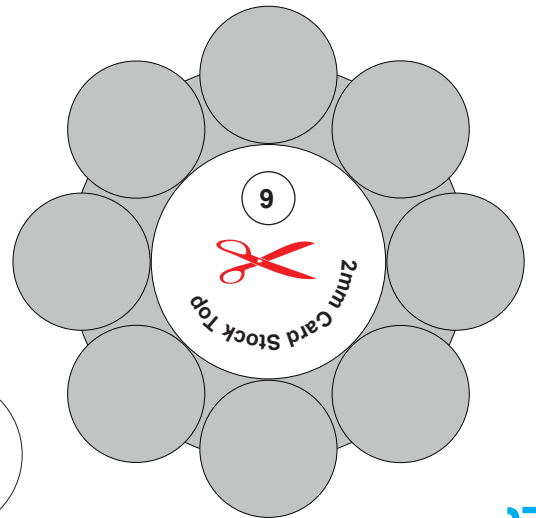
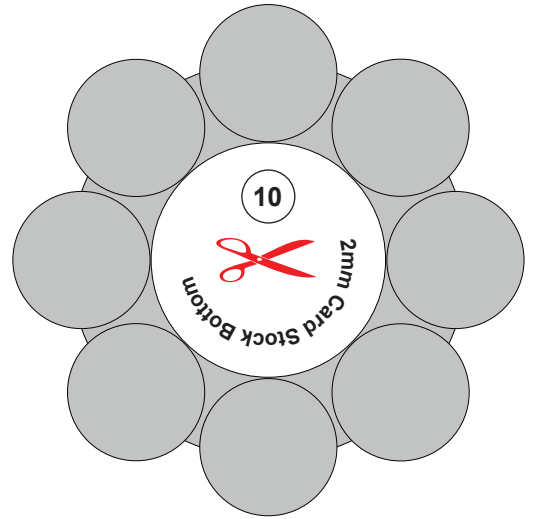
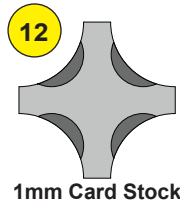
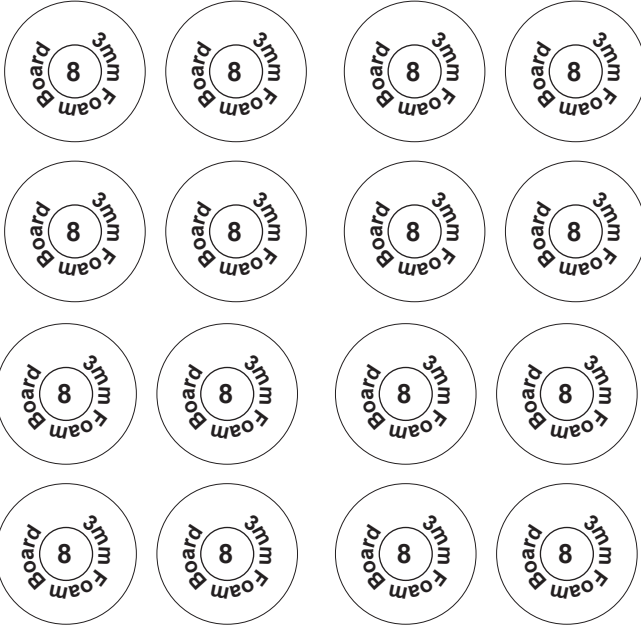
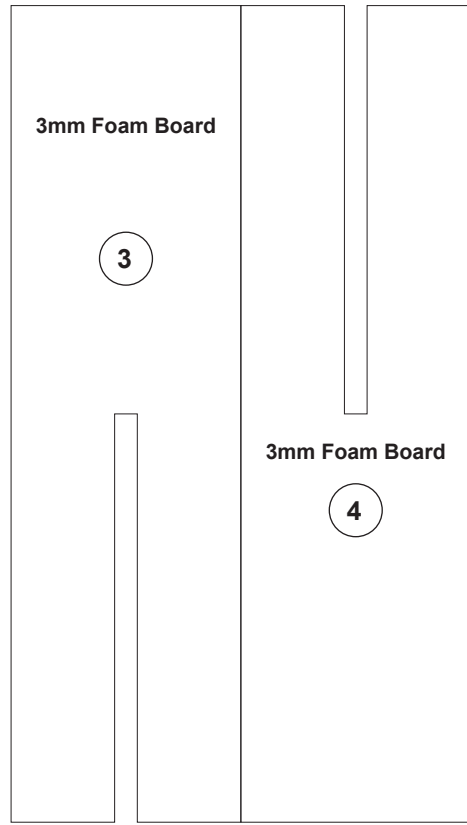
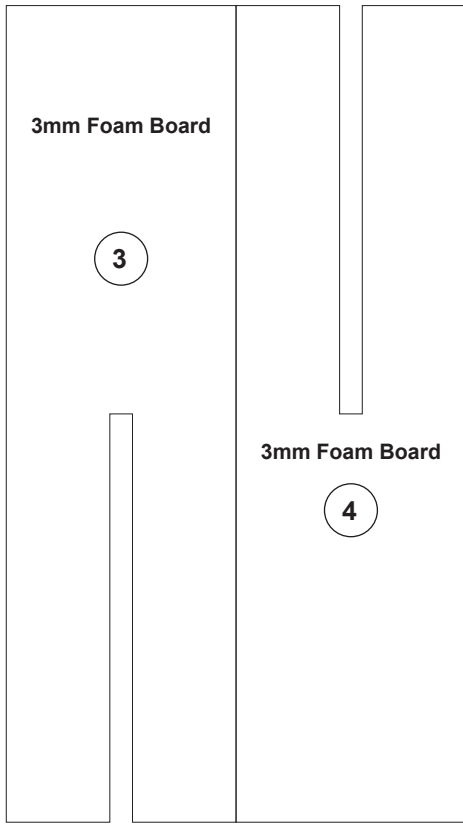

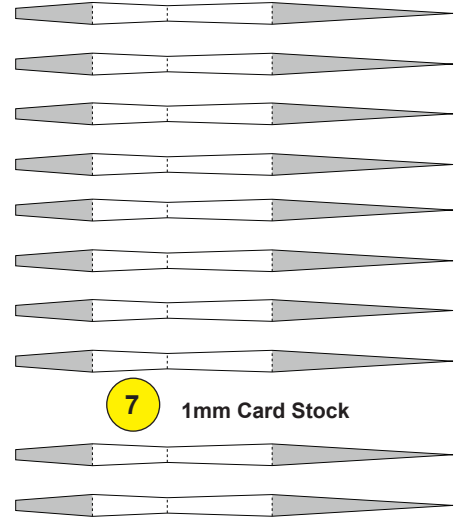
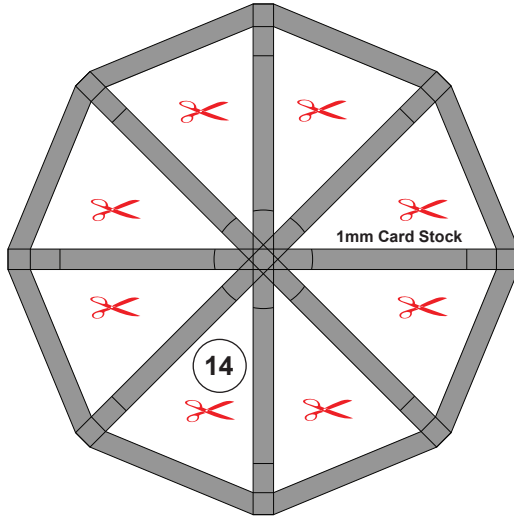
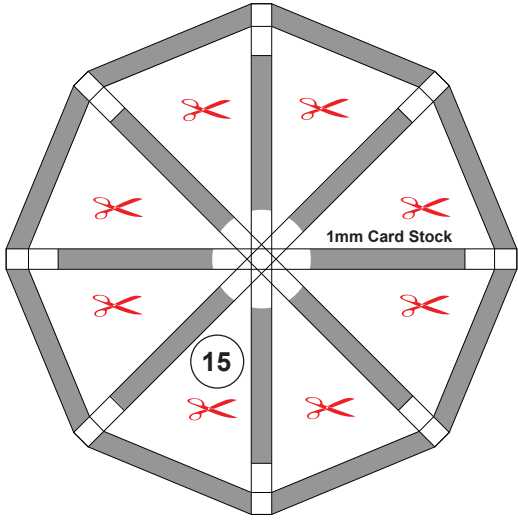

**1** 2mm Card Stock

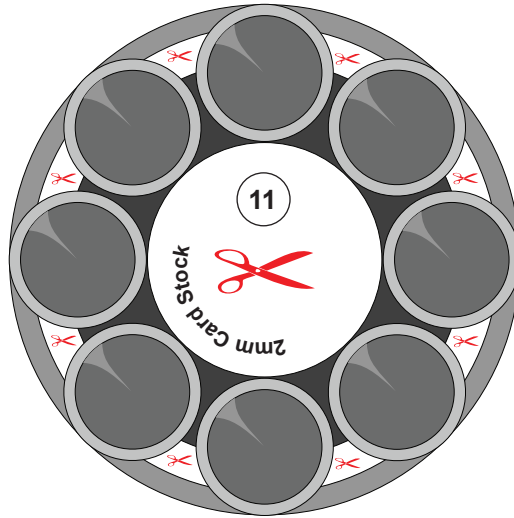
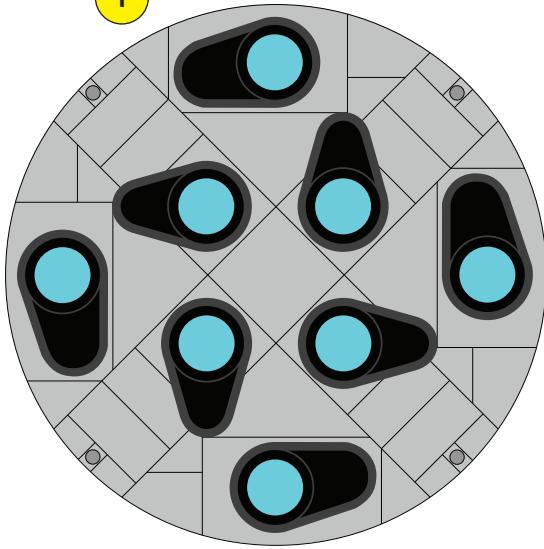

**6** 1mm Card Stock

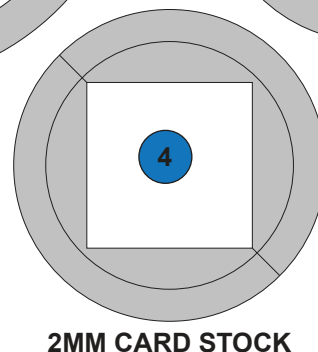
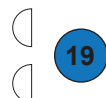
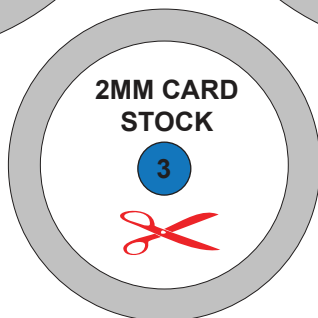
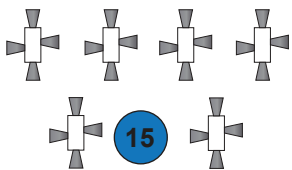
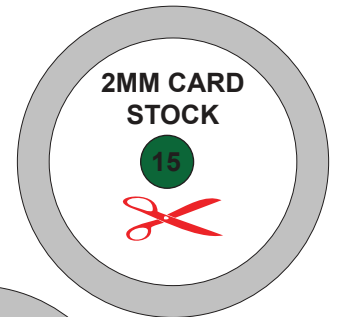
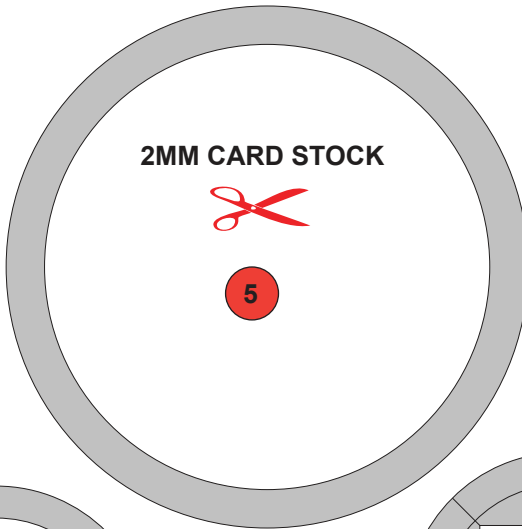
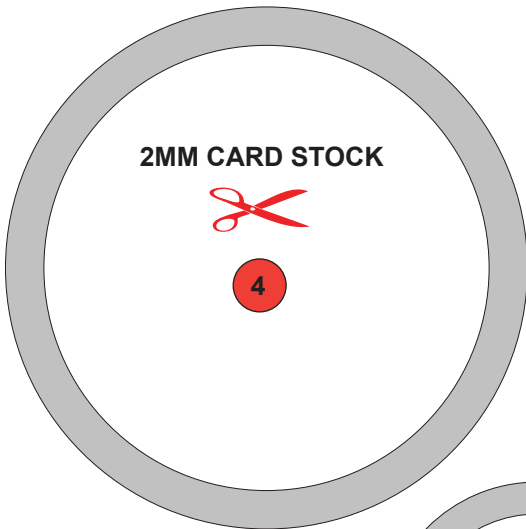
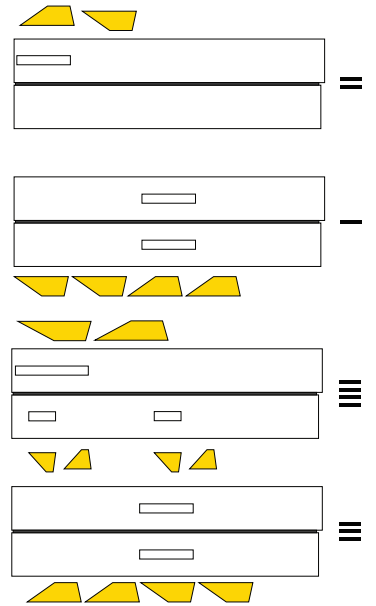

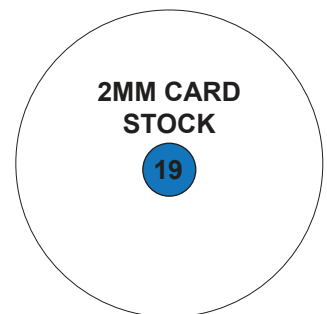
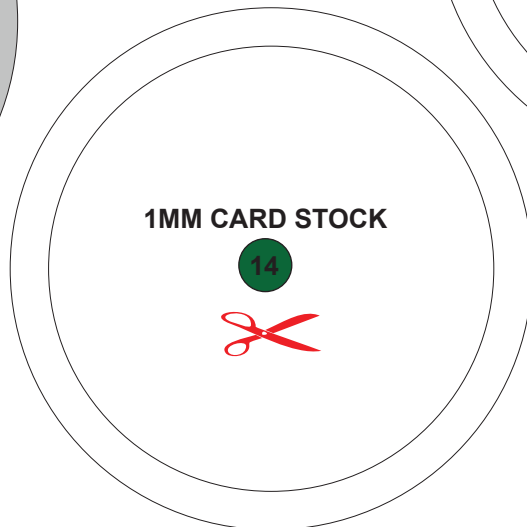
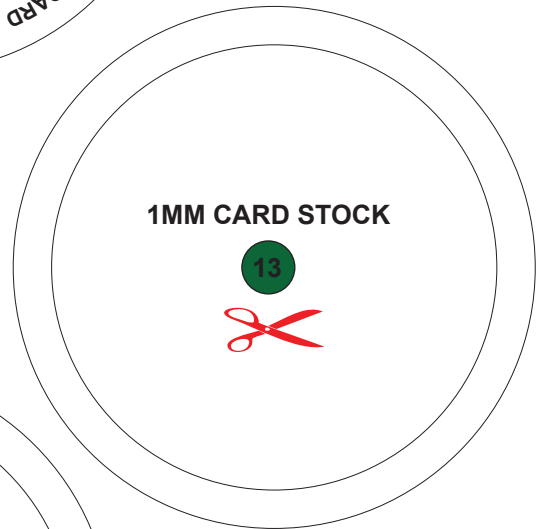
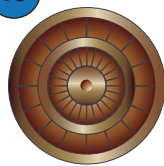
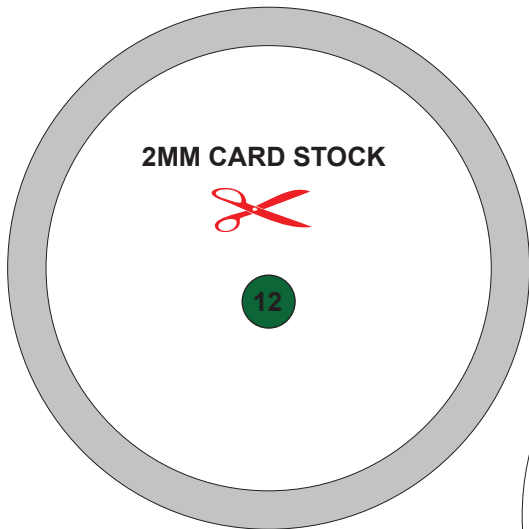
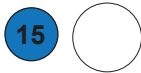
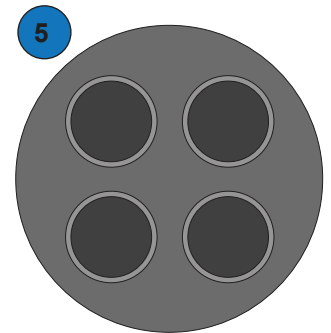
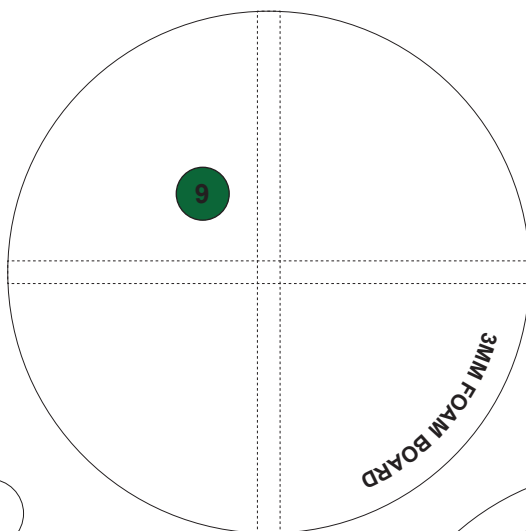
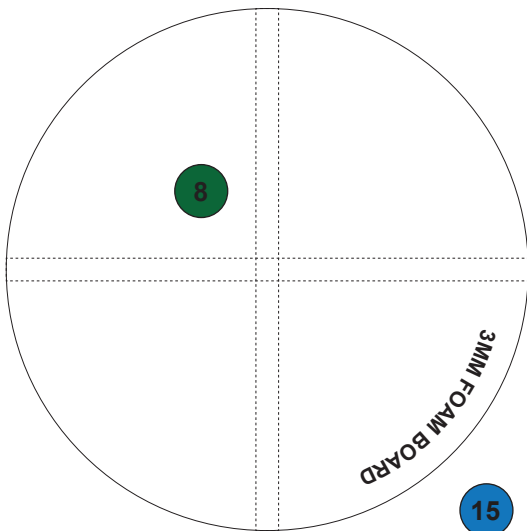
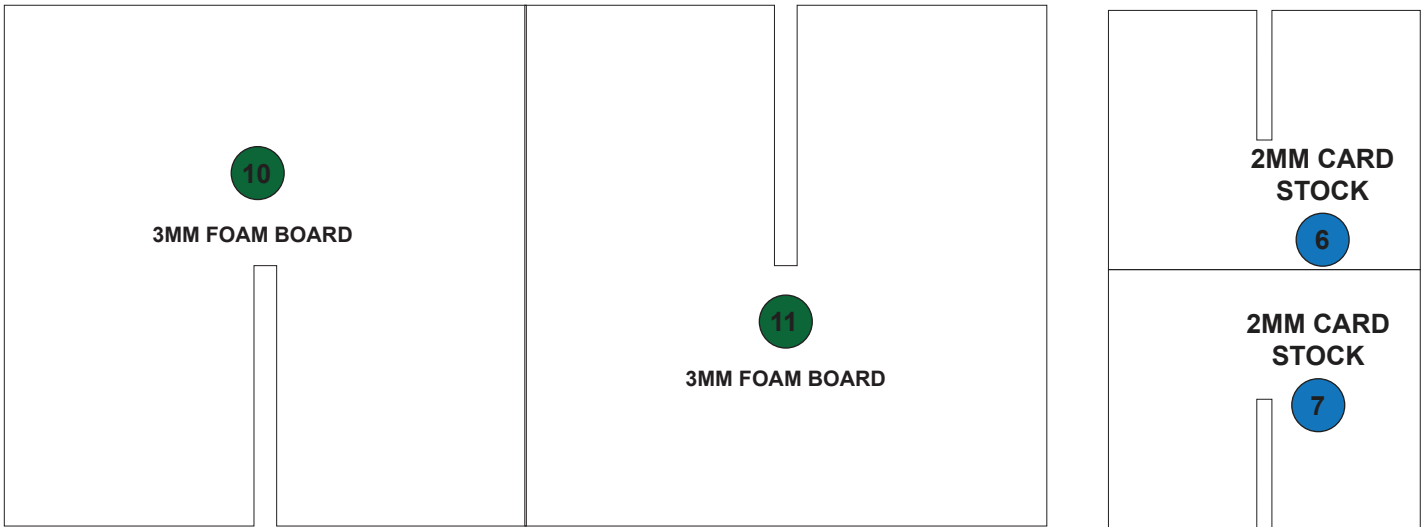

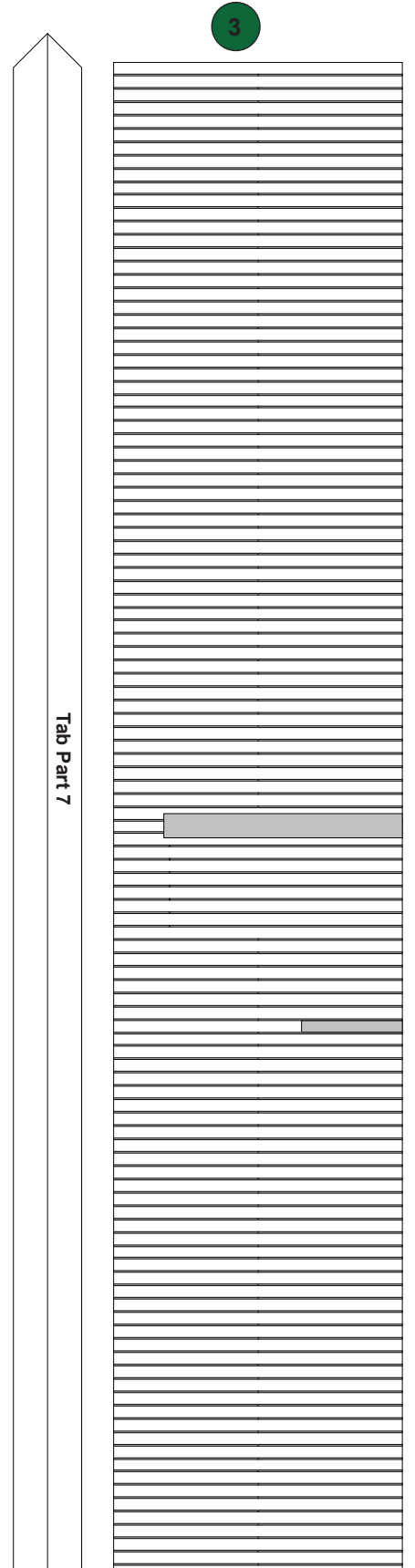
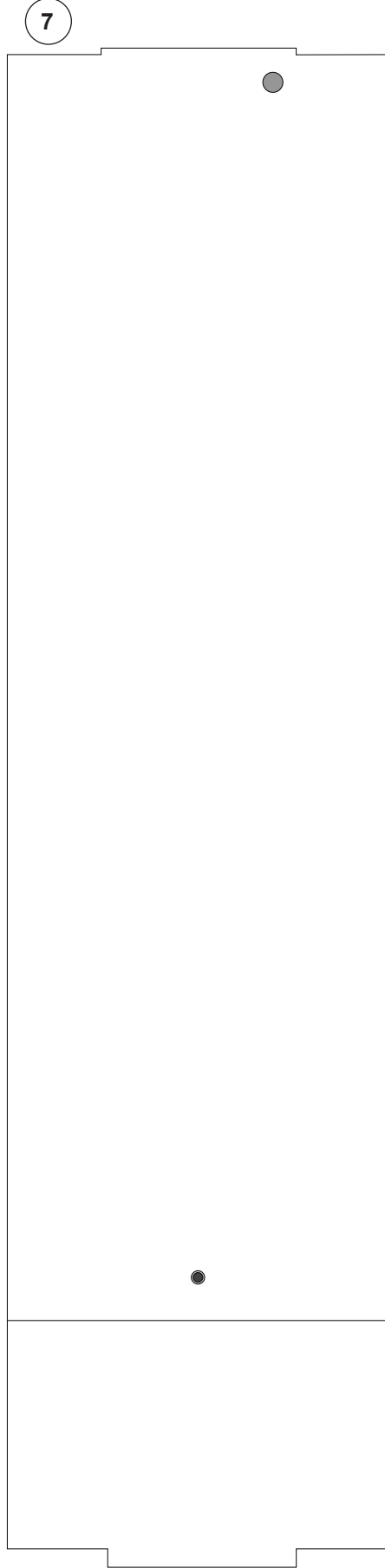
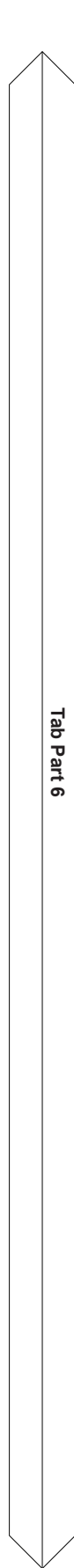
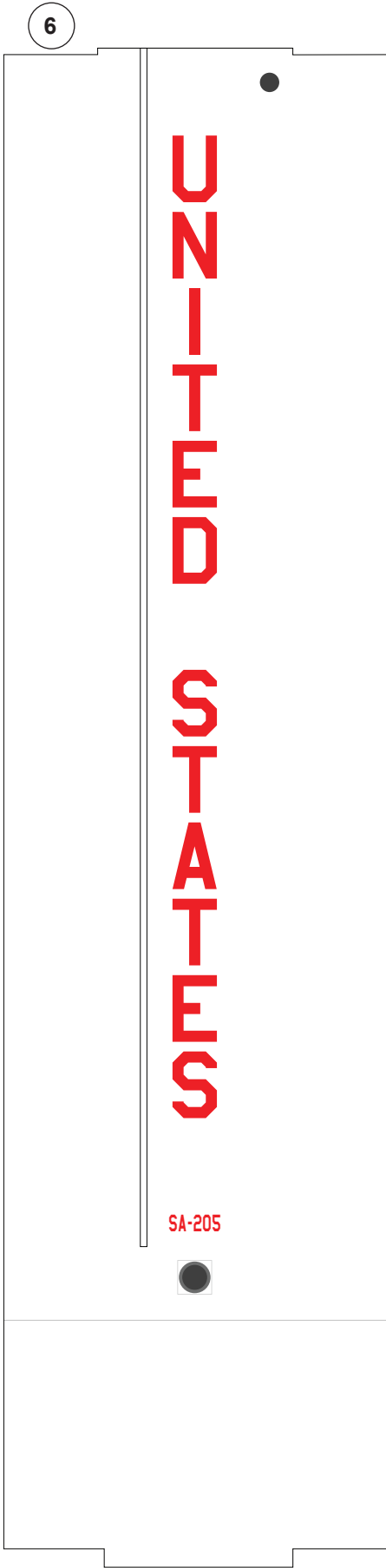



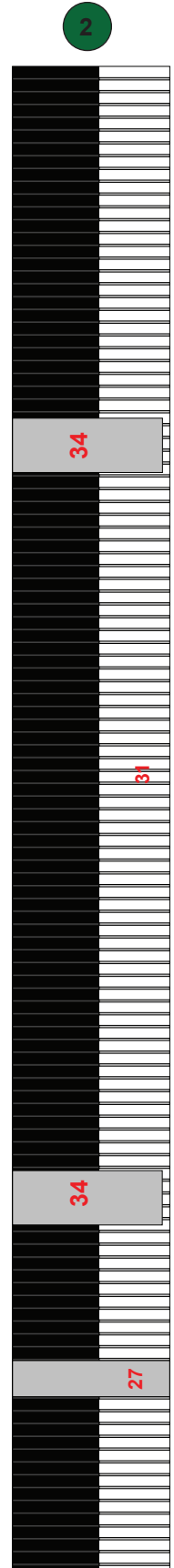
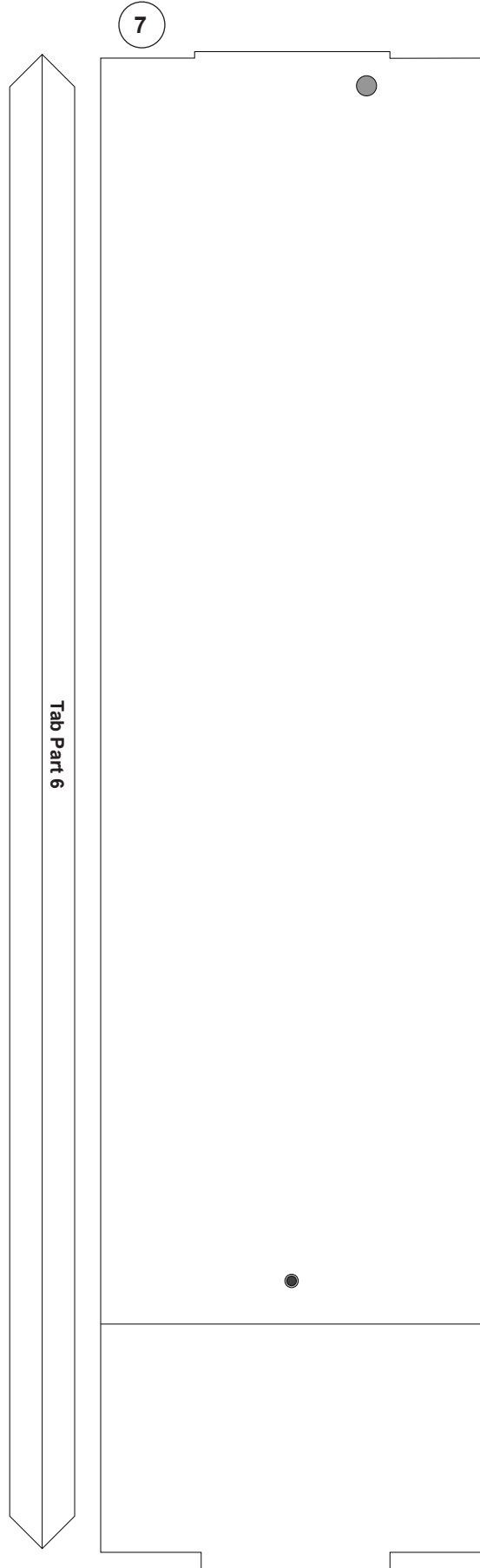
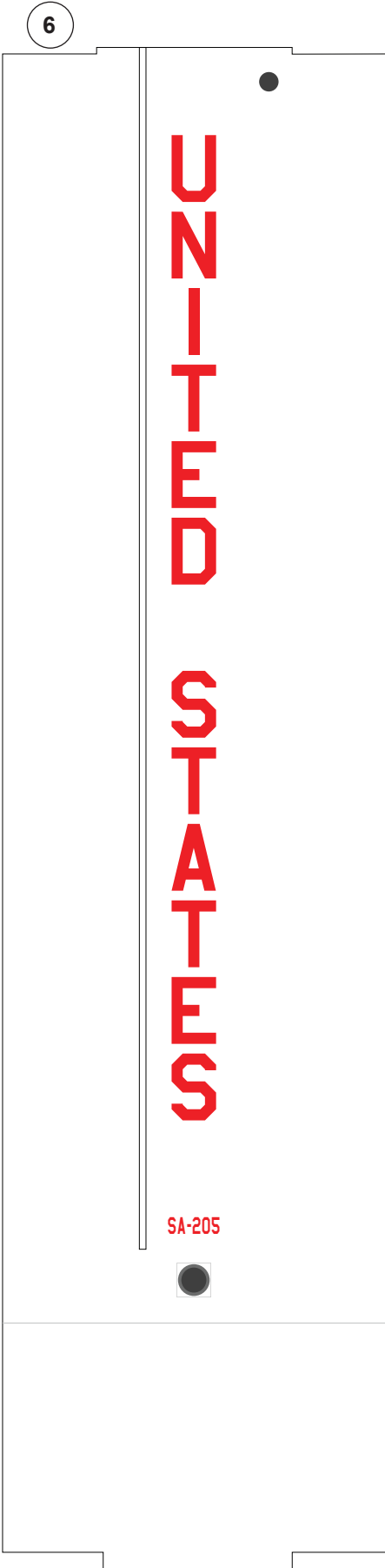

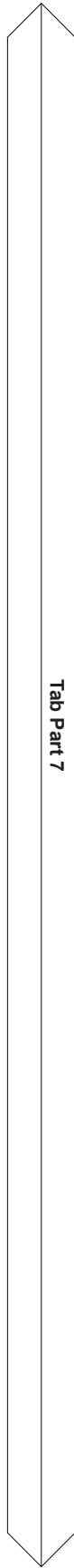
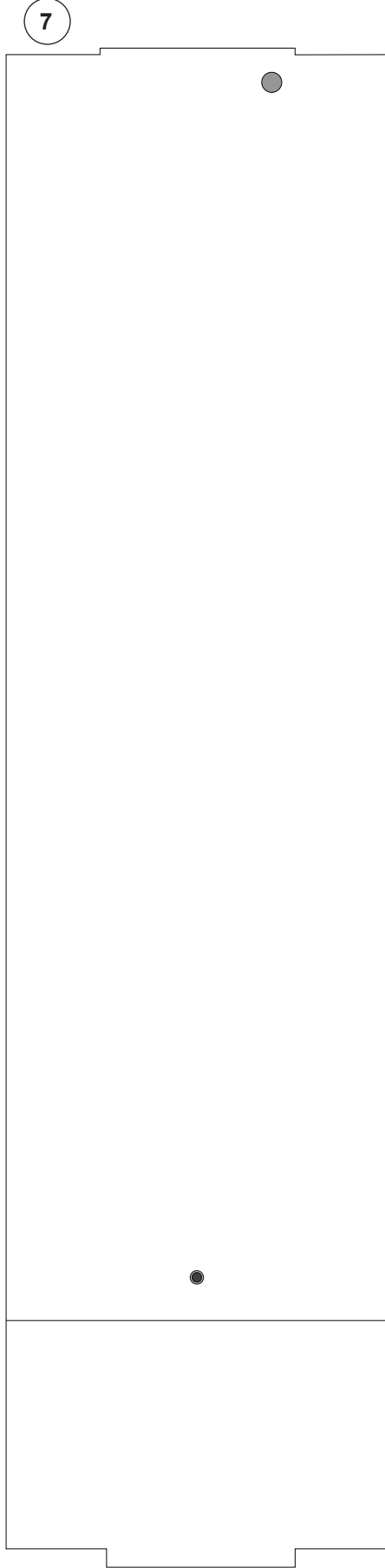
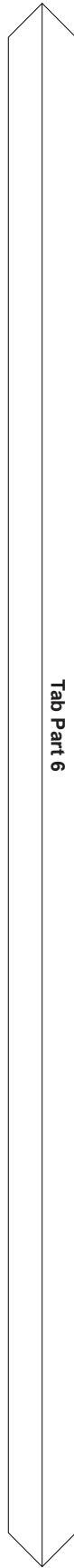
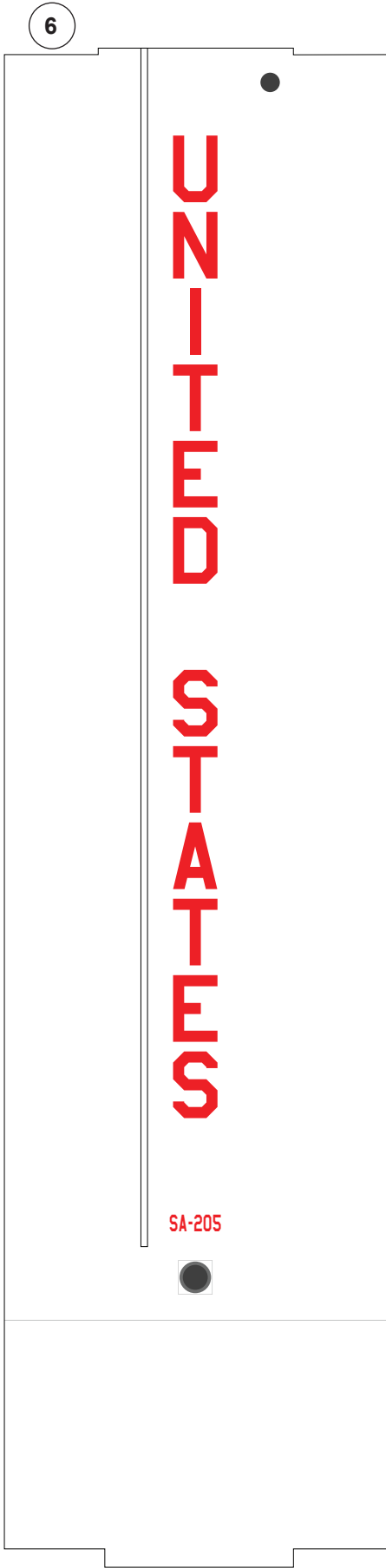

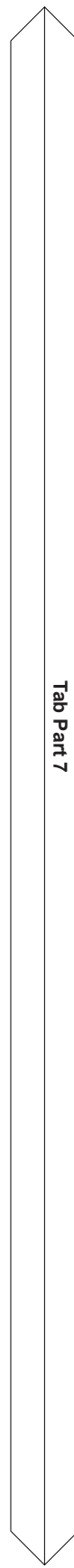
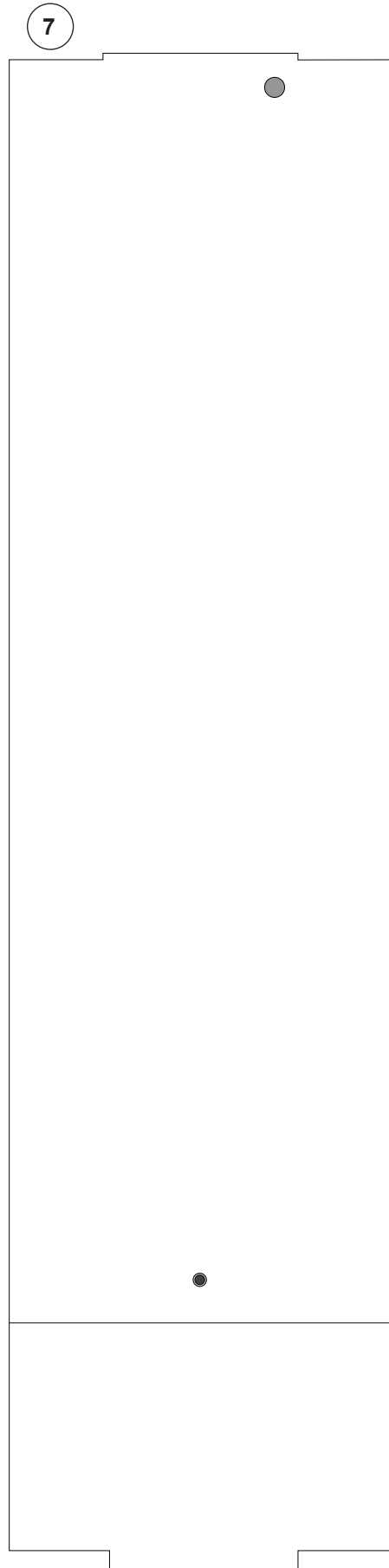
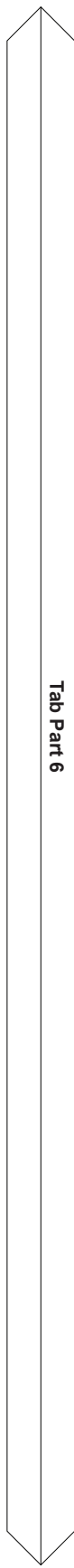
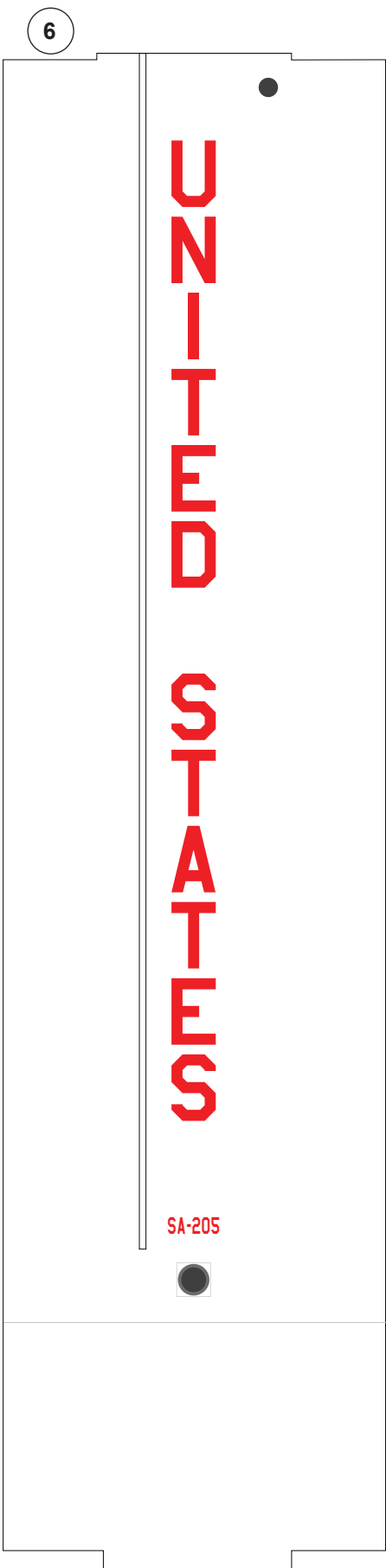

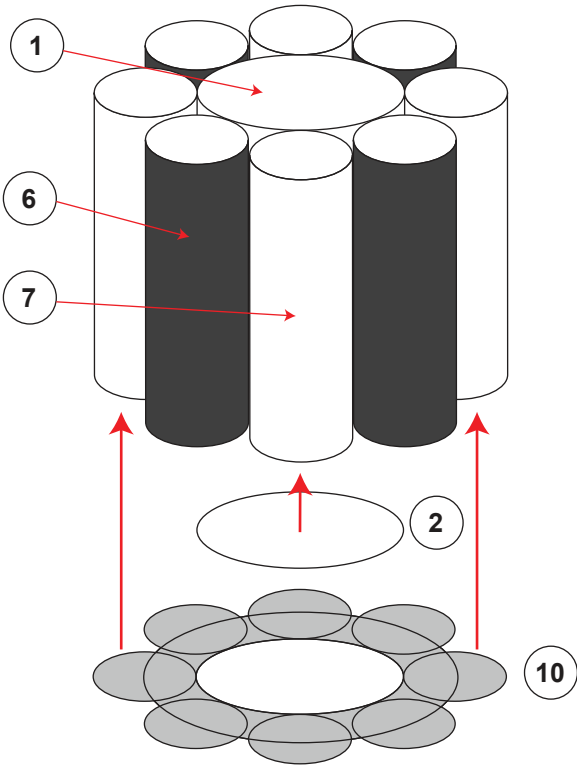

Glue 12 & 13 together and then attach to the rest of the assembly. Finally insert the spider.

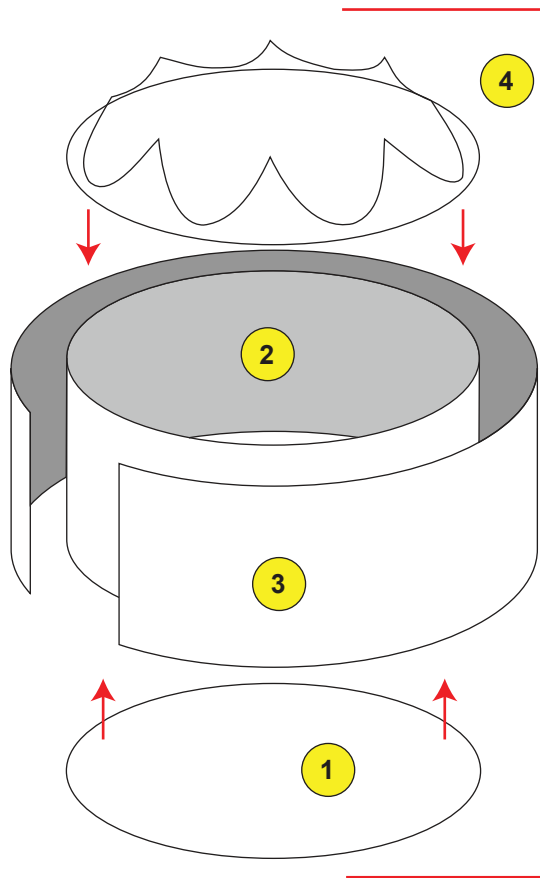

First assemble and then mate to top section

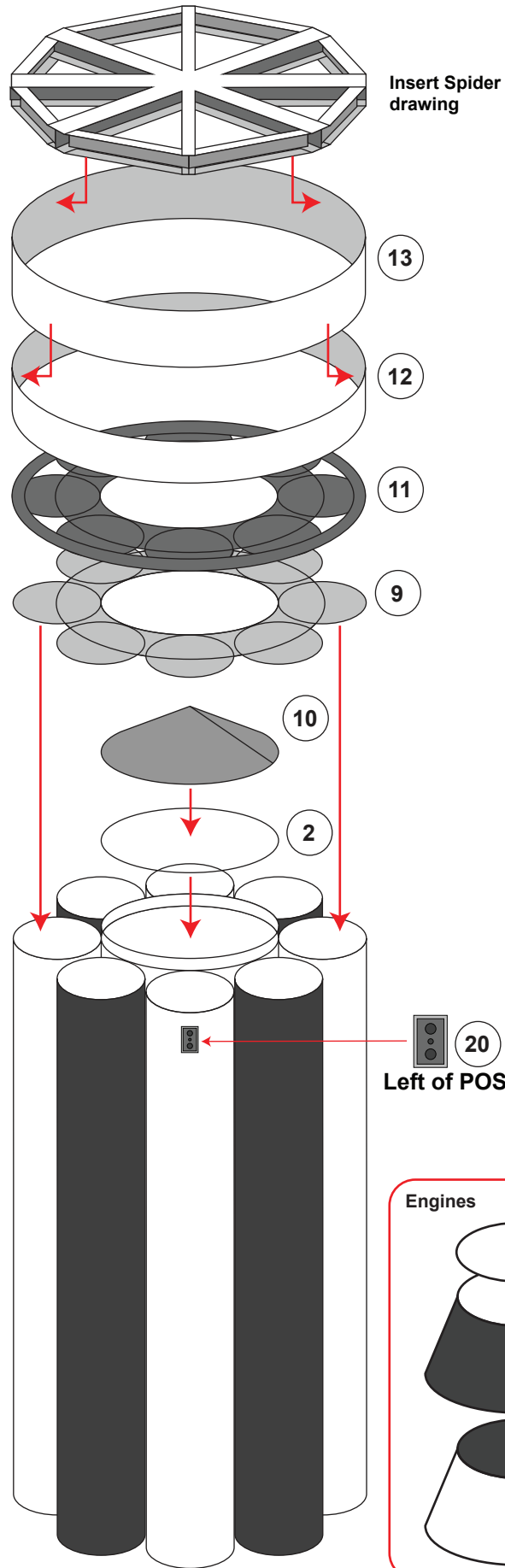

20  
 Left of POS II

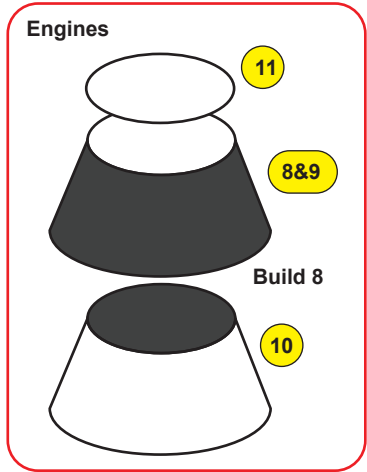



Glue 16 and 17 to create the vertical for the H beam  
Glue onto part 14 and then close with part 15.  
Attach 18 and 19 as indicated.  
Parts 21, 22 and 23 covers are optional

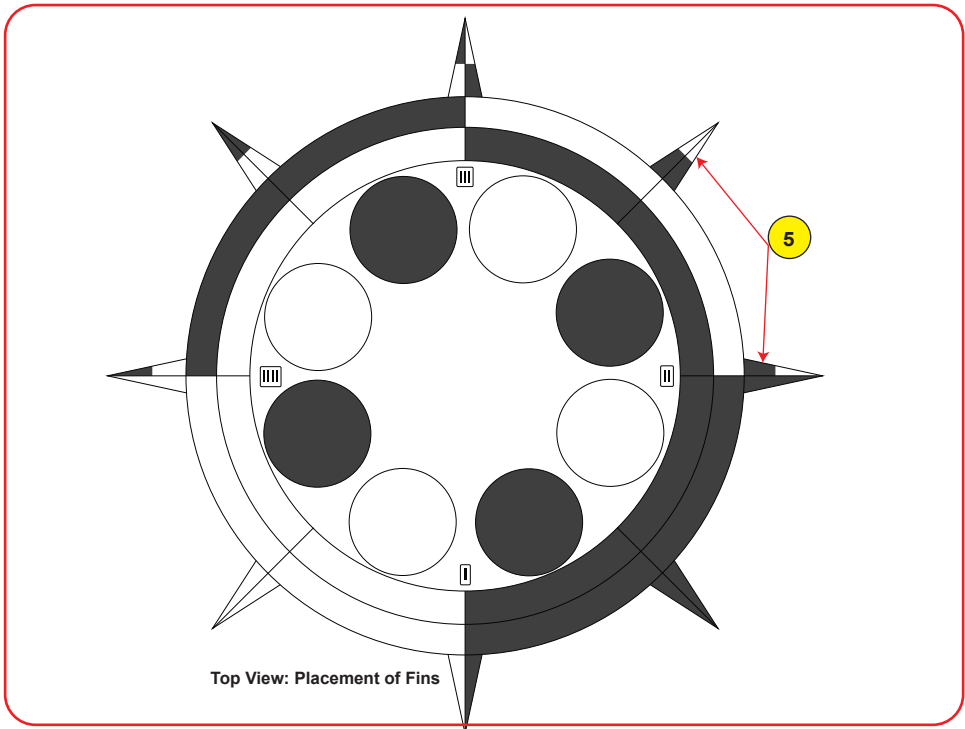
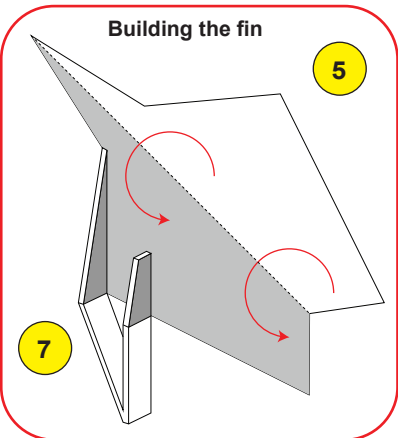
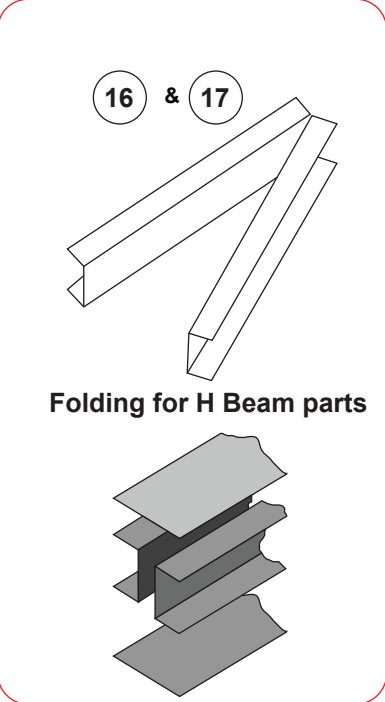
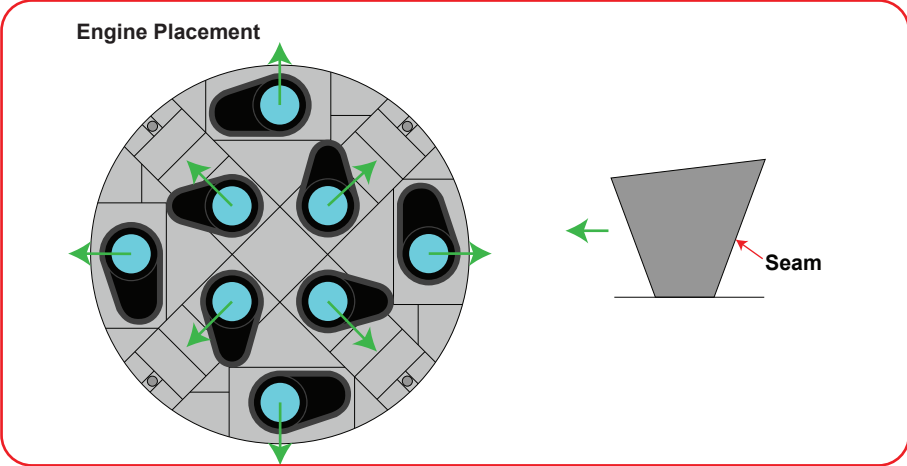
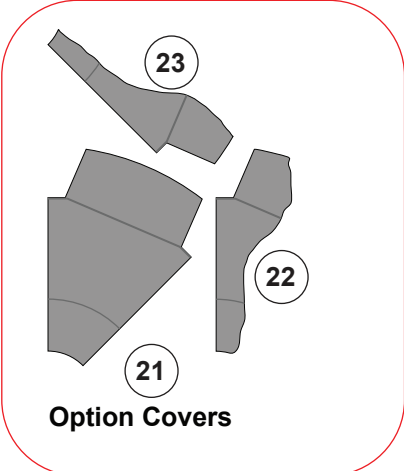
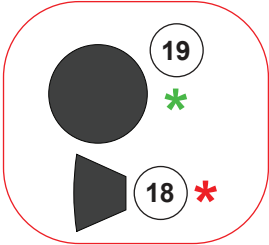
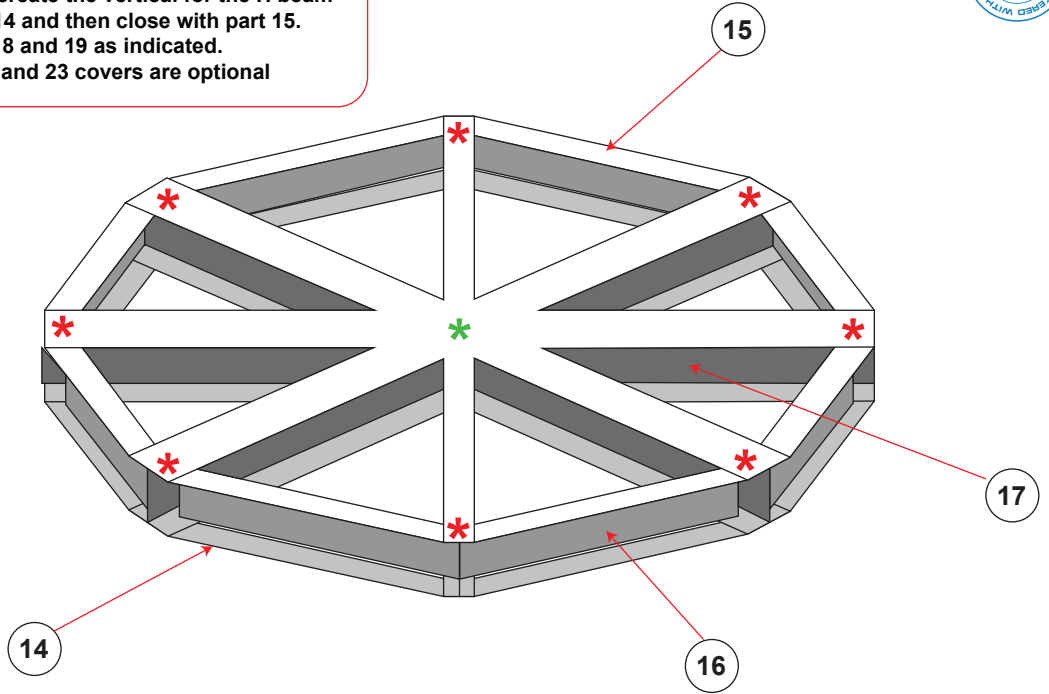

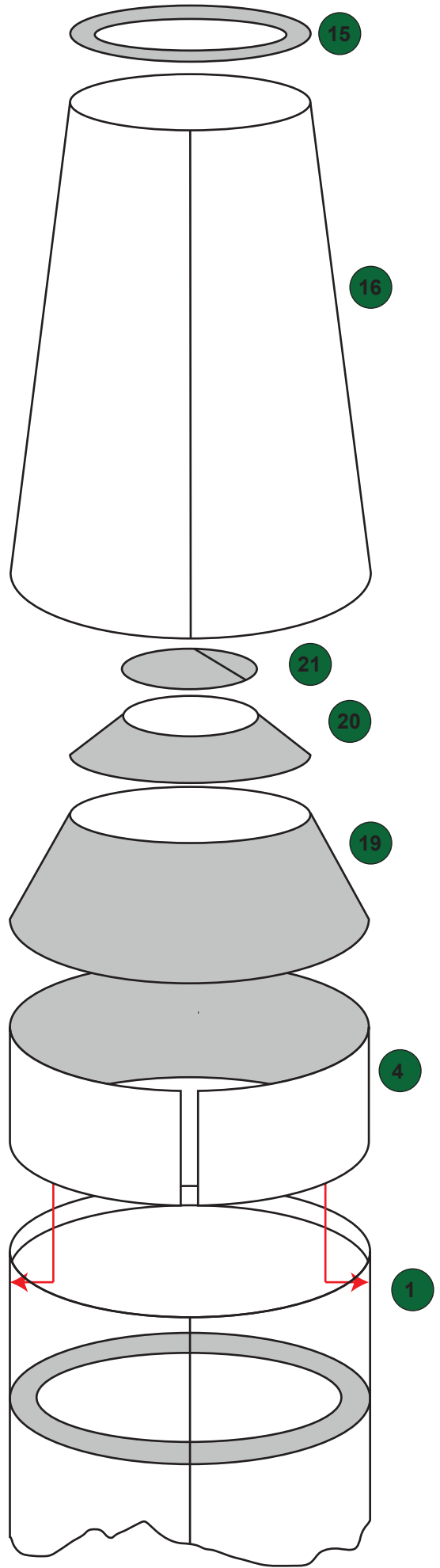
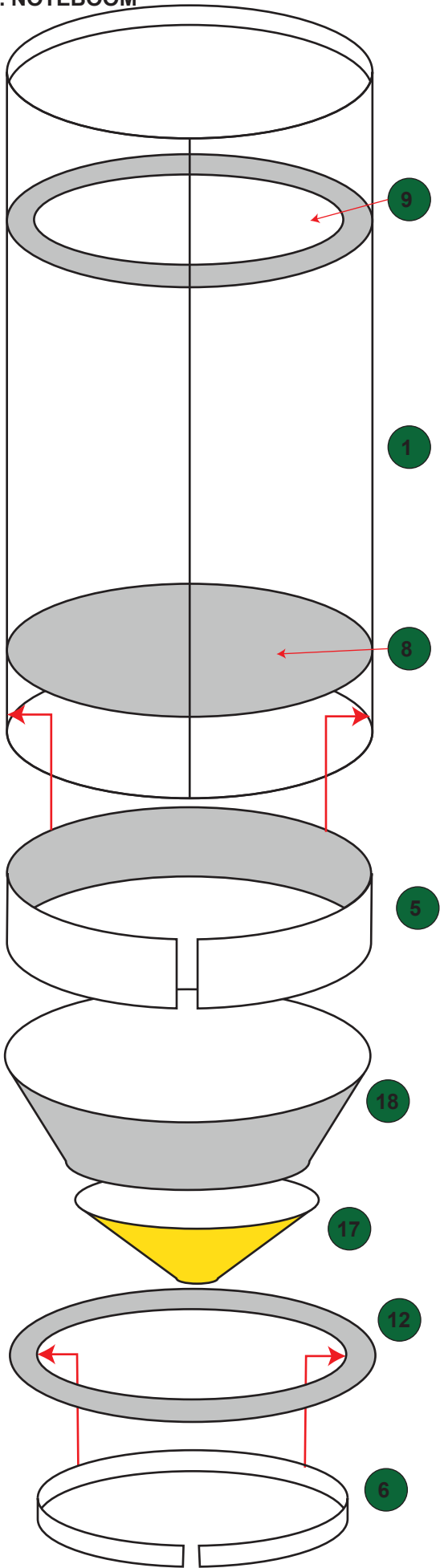

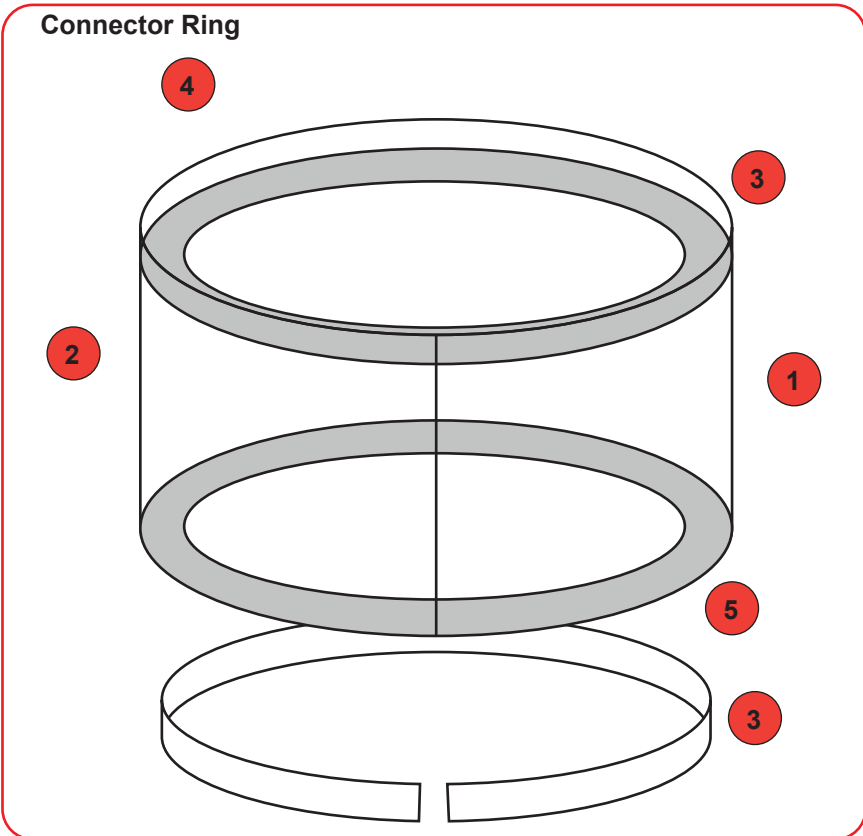
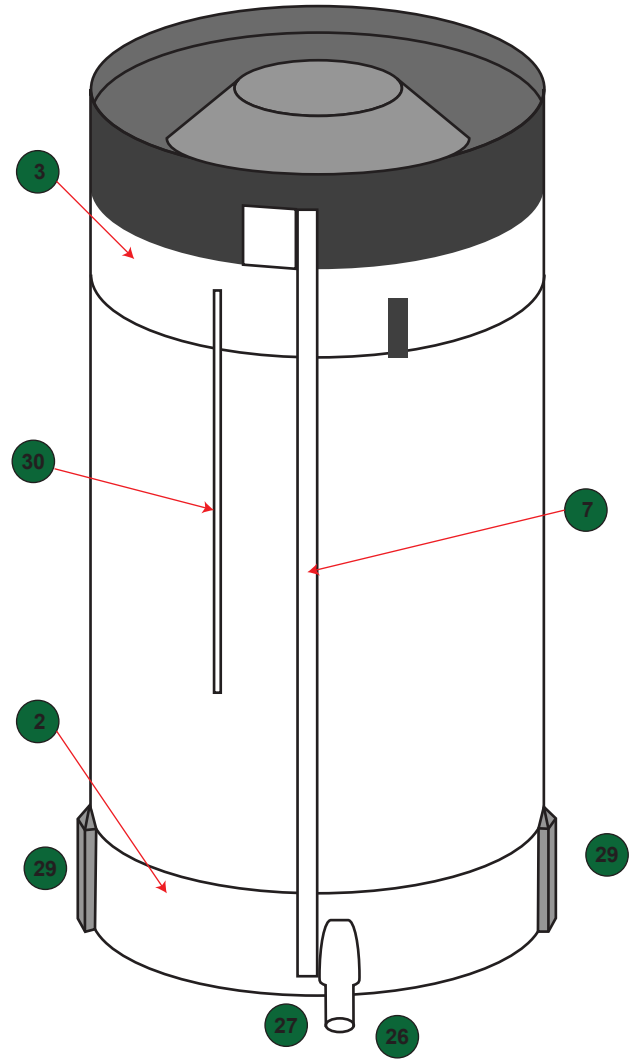
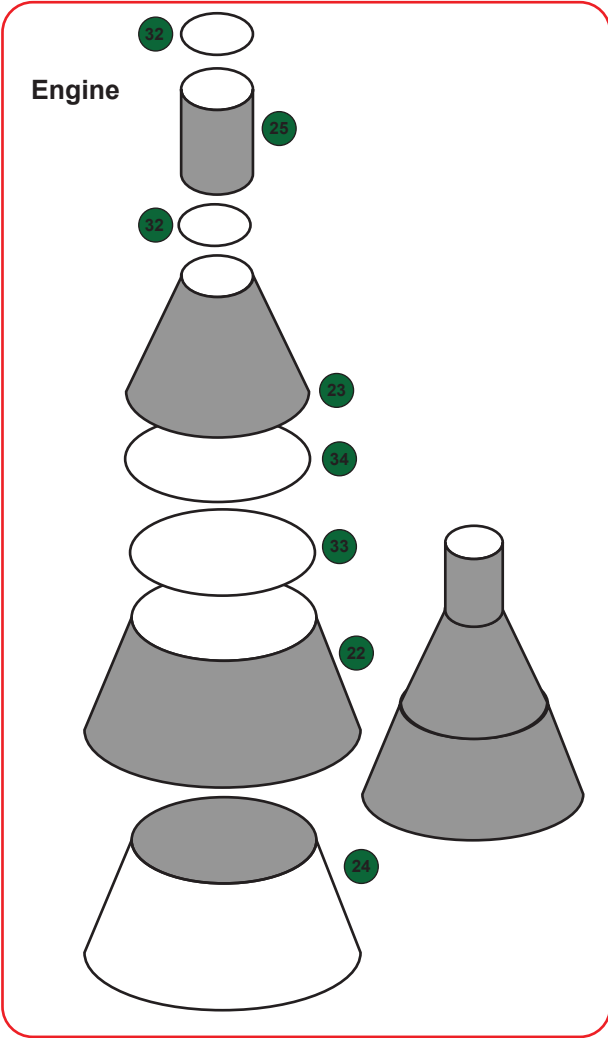

PLACEMENT OF DETAIL PARTS

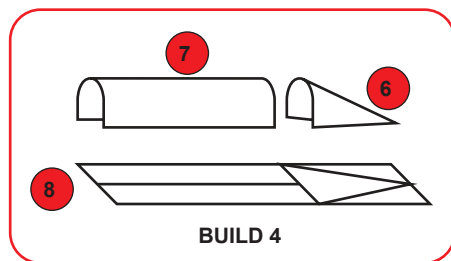
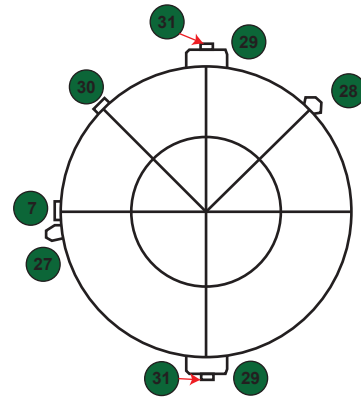

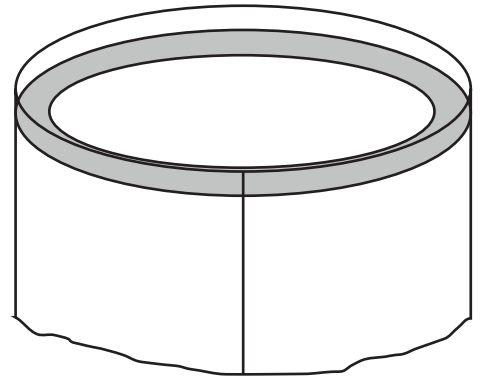
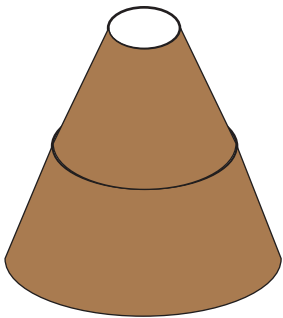
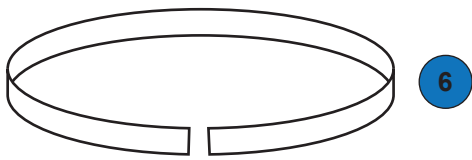
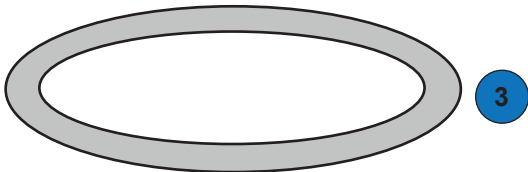
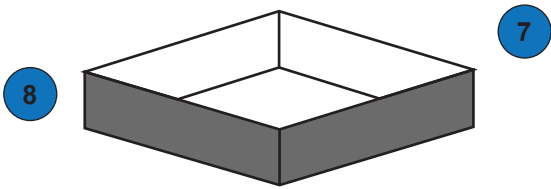
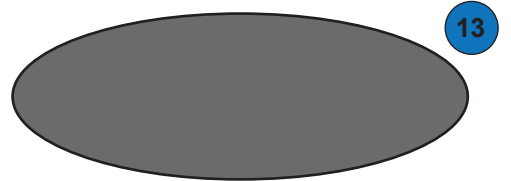
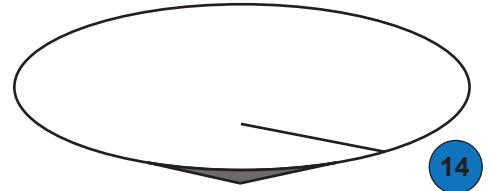
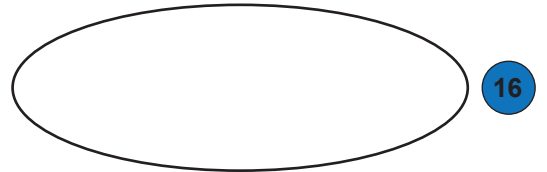
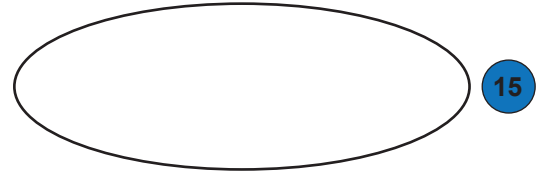
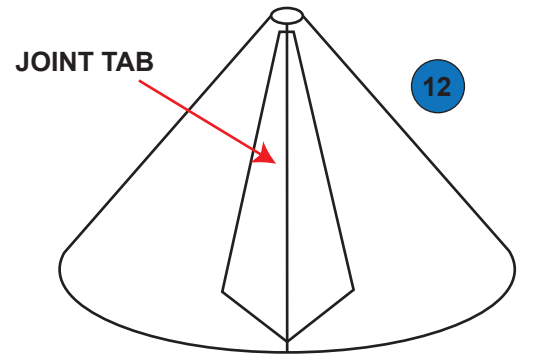
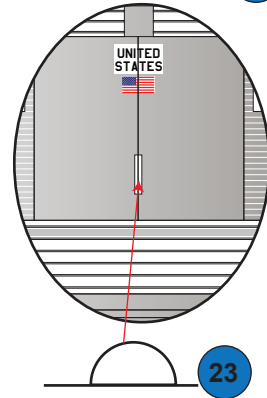
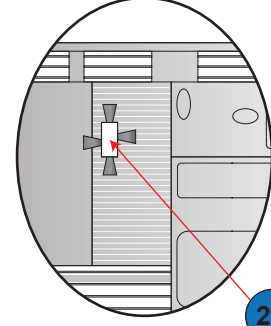
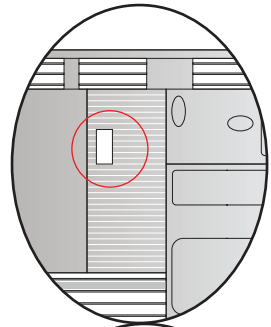
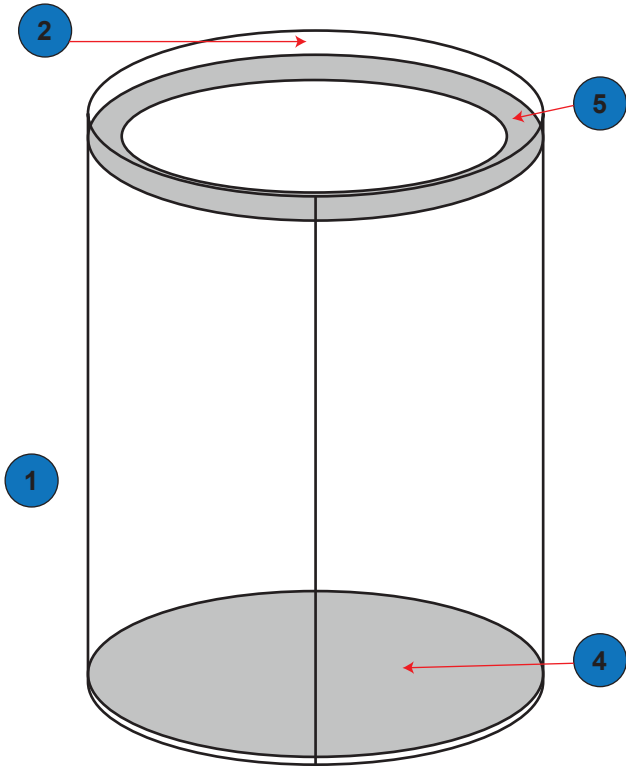





COMMAND MODULE ENGINE

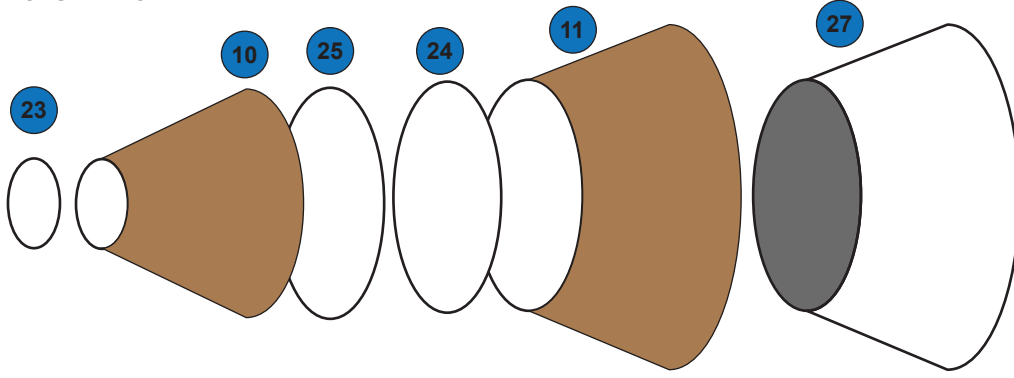

ESCAPE TOWER

